

# Part IA Engineering Mathematics: Lent Term

Convolution

**Fourier Series**

Probability

Joan Lasenby  
Lent 2014

# Section 5

## Fourier Series

The concept of Fourier series is introduced using an analogy with splitting vectors up into components.

The symmetry properties that enable us to predict that certain coefficients are zero are presented.

# Motivation

We mentioned at the start of the last section that sine waves have a special property in relation to linear systems [recall that proving this was the same as shift invariance was left as an exercise then discussed at end of Section 4].

A sine wave at the input leads to a sine wave (same frequency but possibly different phase and amplitude) at the output.



It would therefore be useful to be able to express an arbitrary signal in terms of a sum of sine waves.

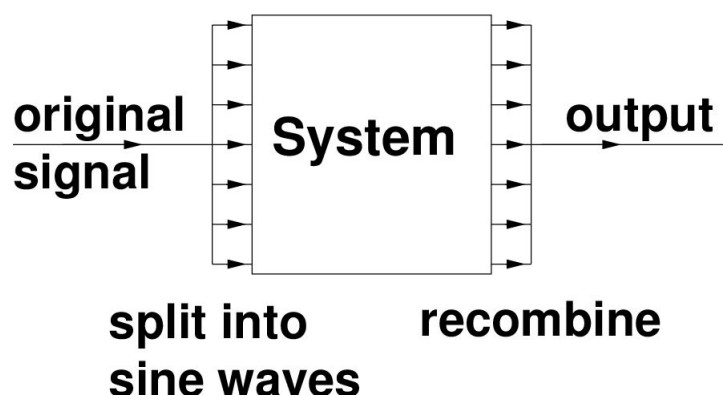

# Motivation: Car Suspension

Supposing we know that our car suspension will start to oscillate (bounce up and down uncomfortably) at frequency  $f$ .

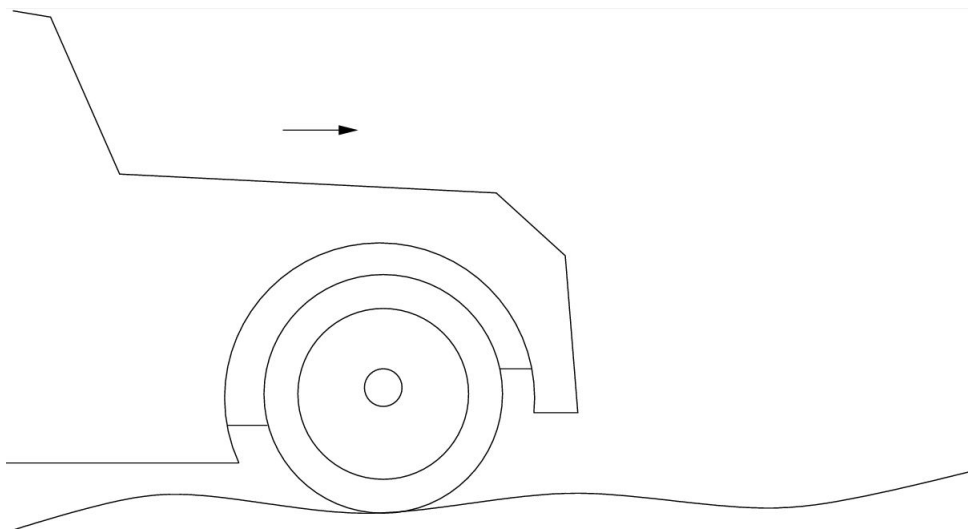

We want to measure a variety of typical road profiles and calculate how much of frequency  $f$  they each contain (with the car travelling at a particular speed).

This will tell us which combinations of road profile and speed are likely to be a problem.

The concept of a **Fourier series** enables us to represent the road profile as the sum of a set of sinusoidal components at different frequencies.

# Splitting up Vectors

We want to express a signal  $f(t)$  in the range  $-\pi \leq t \leq \pi$  in terms of some basic signals, i.e. sine waves. Let's look first at how we do a similar thing with vectors.

Consider how we express the arbitrary vector  $\mathbf{r}$  in terms of the basis vectors  $\mathbf{i}$  and  $\mathbf{j}$ .

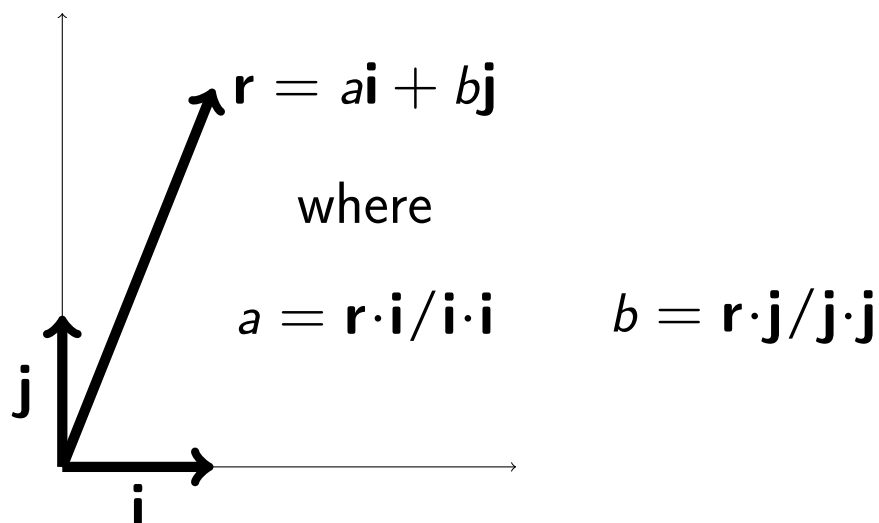

The basis vectors are orthogonal:  $\mathbf{i} \cdot \mathbf{j} = 0$ .

# Basis Functions

Just as we represent  $\mathbf{r}$  using orthogonal basis vectors, we want to represent  $f(t)$  in the range  $-\pi$  to  $\pi$  using orthogonal basis functions. For  $\mathbf{r}$  in 2D we only need two vectors, but for  $f(t)$  we need an infinite number of functions – these are:

$$\begin{array}{l} 1 \text{ (i.e. a constant term)} \\ \cos(t) \quad \cos(2t) \quad \cos(3t) \quad \cos(4t) \quad \dots \\ \sin(t) \quad \sin(2t) \quad \sin(3t) \quad \sin(4t) \quad \dots \end{array}$$

If  $n$  and  $m$  are positive integers greater than zero.

$$\begin{aligned} \int_{-\pi}^{\pi} \cos(nt) \sin(mt) dt &= 0 \\ \int_{-\pi}^{\pi} \cos(nt) \times 1 dt &= 0 \\ \int_{-\pi}^{\pi} \sin(nt) \times 1 dt &= 0 \\ \int_{-\pi}^{\pi} \cos(nt) \cos(mt) dt &= \begin{cases} 0 & n \neq m \\ \pi & n = m \end{cases} \\ \int_{-\pi}^{\pi} \sin(nt) \sin(mt) dt &= \begin{cases} 0 & n \neq m \\ \pi & n = m \end{cases} \\ \int_{-\pi}^{\pi} 1 \times 1 dt &= 2\pi \end{aligned}$$



So, using  $\int_{-\pi}^{\pi} p(t)q(t) dt$  as our “dot product for functions”, the basis functions are orthogonal.

# Fourier Series

If  $\mathbf{r} = a\mathbf{i} + b\mathbf{j}$ , we obtain  $a$  and  $b$  by dotting  $\mathbf{r}$  with  $\mathbf{i}$  and  $\mathbf{j}$  respectively:

$$\mathbf{r} \cdot \mathbf{i} = a \mathbf{i} \cdot \mathbf{i}$$

$$\mathbf{r} \cdot \mathbf{j} = b \mathbf{j} \cdot \mathbf{j}$$

since  $\mathbf{i} \cdot \mathbf{j} = 0$ . Thus  $a = (\mathbf{r} \cdot \mathbf{i}) / (\mathbf{i} \cdot \mathbf{i})$  and  $b = (\mathbf{r} \cdot \mathbf{j}) / (\mathbf{j} \cdot \mathbf{j})$ .

Now, if we have a function  $f(t)$  which can be expressed as a linear combination of our harmonic basis functions, i.e.



$$f(t) = a_0 + \sum_{n=1}^{\infty} a_n \cos(nt) + \sum_{n=1}^{\infty} b_n \sin(nt)$$

[ $a_0$  is a constant]. We find the  $a_n$  and the  $b_n$  by exploiting the fact that our basis functions are orthogonal under integration between  $-\pi$  and  $\pi$  so that:

$$\int_{-\pi}^{\pi} \cos(nt) f(t) dt = a_n \int_{-\pi}^{\pi} \cos(nt) \cos(nt) dt$$

and

$$\int_{-\pi}^{\pi} \sin(nt) f(t) dt = b_n \int_{-\pi}^{\pi} \sin(nt) \sin(nt) dt$$

Thus we are able to find  $a_n$  and  $b_n$  from the above expressions:

$$a_n = \frac{\int_{-\pi}^{\pi} \cos(nt) f(t) dt}{\int_{-\pi}^{\pi} \cos(nt) \cos(nt) dt} = \frac{1}{\pi} \int_{-\pi}^{\pi} \cos(nt) f(t) dt$$

$$b_n = \frac{\int_{-\pi}^{\pi} \sin(nt) f(t) dt}{\int_{-\pi}^{\pi} \sin(nt) \sin(nt) dt} = \frac{1}{\pi} \int_{-\pi}^{\pi} \sin(nt) f(t) dt$$

$$a_0 = \frac{\int_{-\pi}^{\pi} 1 \times f(t) dt}{\int_{-\pi}^{\pi} 1 \times 1 dt} = \frac{1}{2\pi} \int_{-\pi}^{\pi} f(t) dt$$



$$f(t) = a_0 + \sum_{n=1}^{\infty} a_n \cos(nt) + \sum_{n=1}^{\infty} b_n \sin(nt)$$



# Fourier Series: Example 1

Represent the square wave  $f(t)$  as a Fourier series.

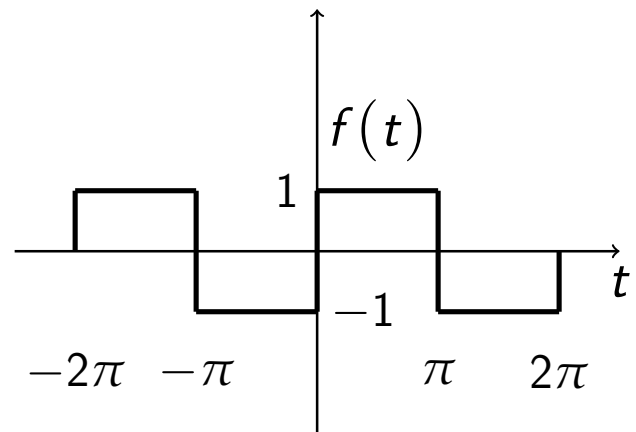

$$a_n = \frac{1}{\pi} \int_{-\pi}^{\pi} \cos(nt) f(t) dt = 0 \quad n \neq 0$$

$$b_n = \frac{1}{\pi} \int_{-\pi}^{\pi} \sin(nt) f(t) dt = \frac{2(1 - (-1)^n)}{n\pi}$$

$$a_0 = \frac{1}{2\pi} \int_{-\pi}^{\pi} f(t) dt = 0$$

The  $a_n$  integrands are *odd* while the  $b_n$  integrands are *even*. Thus, we can model the square wave (of period  $2\pi$ ) function  $f(t)$  (odd and of period  $2\pi$ ) using:



$$\begin{aligned} f(t) &= a_0 + \sum_{n=1}^{\infty} (a_n \cos(nt) + b_n \sin(nt)) \\ &= \sum_{n=1}^{\infty} \frac{2(1 - (-1)^n)}{n\pi} \sin(nt) \\ &= \frac{4}{\pi} \left[ \sin(t) + \frac{\sin(3t)}{3} + \frac{\sin(5t)}{5} + \dots \right] \end{aligned}$$

# Fourier Series Properties

1. We can use any range of length  $2\pi$  instead of  $-\pi \leq t \leq \pi$  in the Fourier formulae. For example,  $0 \leq t \leq 2\pi$  is equally OK.



2. We are only modelling the function  $f(t)$  in the specified range (eg.  $-\pi$  to  $\pi$ , or  $0$  to  $2\pi$ ). Outside this range the model will just repeat with period  $2\pi$ .

This is fine if the function we wish to model is periodic itself, but if the function is *not periodic* the Fourier model will probably only be useful over the range on which it was built.

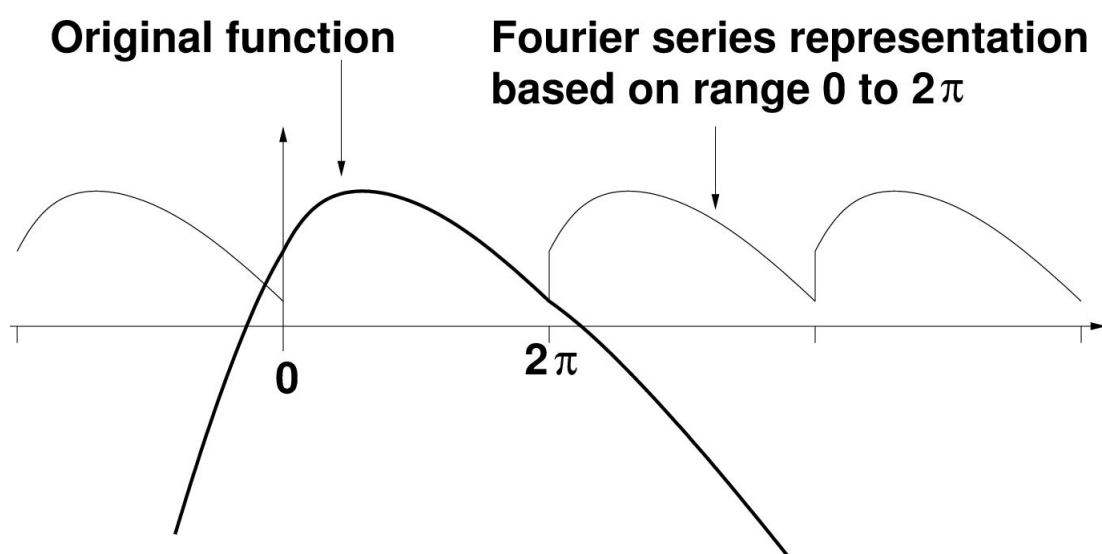

## Fourier Series Example 2

Represent  $f(t) = e^t$  as a Fourier series between  $-\pi$  and  $\pi$ . 

$$a_n = \frac{1}{\pi} \int_{-\pi}^{\pi} \cos(nt) e^t dt = \frac{(-1)^n (e^{\pi} - e^{-\pi})}{\pi (1 + n^2)} \quad n \neq 0$$

$$b_n = \frac{1}{\pi} \int_{-\pi}^{\pi} \sin(nt) e^t dt = \frac{-(-1)^n (e^{\pi} - e^{-\pi}) n}{\pi (1 + n^2)}$$

$$a_0 = \frac{1}{2\pi} \int_{-\pi}^{\pi} e^t dt = \frac{e^{\pi} - e^{-\pi}}{2\pi}$$

Thus, in the range  $-\pi < t < \pi$  we can model the function  $f(t) = e^t$  using:

$$f(t) = a_0 + \sum_{n=1}^{\infty} (a_n \cos(nt) + b_n \sin(nt))$$

$$= \frac{e^{\pi} - e^{-\pi}}{\pi} \left( \frac{1}{2} + \sum_{n=1}^{\infty} \frac{(-1)^n}{1 + n^2} [\cos(nt) - n \sin(nt)] \right)$$

$$\approx 3.68 - 3.68 \cos(t) + 3.68 \sin(t)$$

$$+ 1.47 \cos(2t) - 2.94 \sin(2t) - \dots$$

# Fourier Model of Exponential

Fourier model of  $e^t$   
built on range  $-\pi$   
to  $\pi$ . Repeats every  $2\pi$

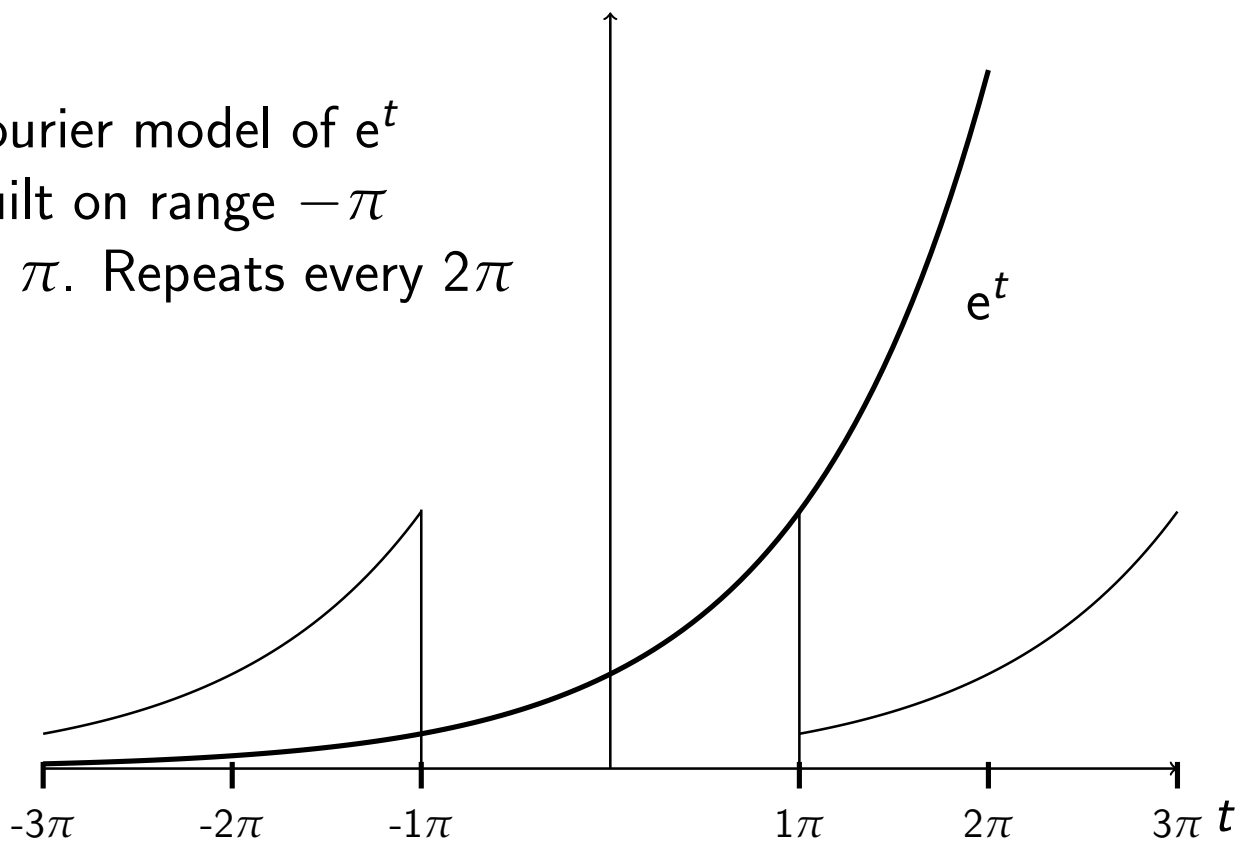

# Symmetric Signals

ODD function  $f(-t) = -f(t)$  eg:  $\sin(t)$

EVEN function  $f(-t) = f(t)$  eg:  $\cos(t)$

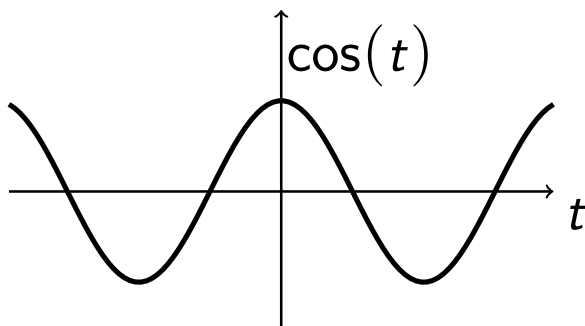

The  $a_n$  terms model the *EVEN* component in the function

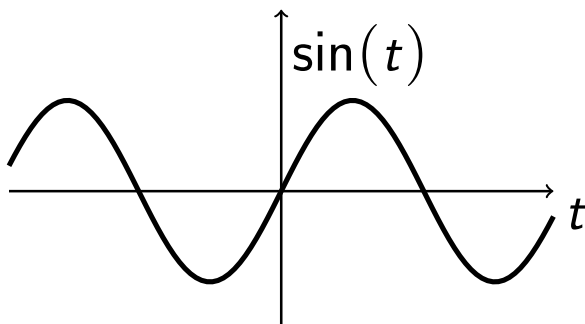

The  $b_n$  terms model the *ODD* component in the function

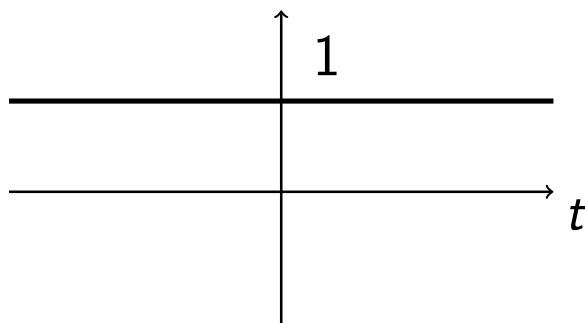

The  $a_0$  term models the mean value of the function

# Avoiding Integration

If we can spot a symmetry in the function to be represented then we can avoid evaluating one or more of the Fourier integrals.

No even component  $\Rightarrow$  all  $a_n = 0$ ,  $n \neq 0$

No odd component  $\Rightarrow$  all  $b_n = 0$

Zero mean  $\Rightarrow a_0 = 0$

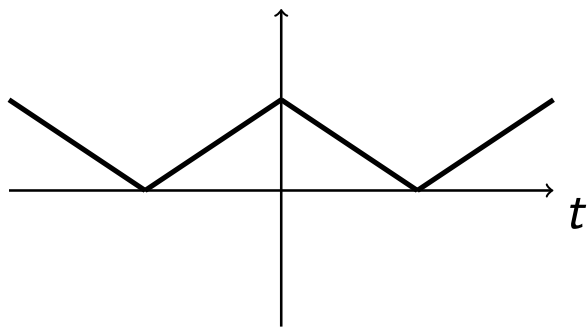

*EVEN* function with non-zero mean:  $b_n = 0$

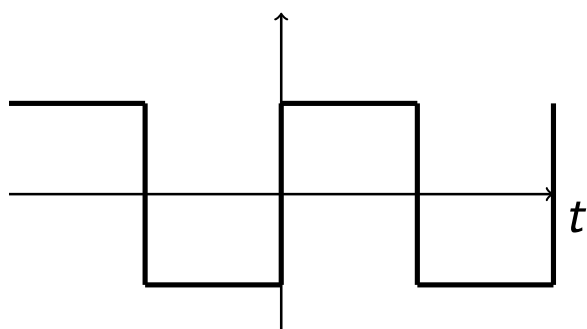

Purely *ODD* function with zero mean:  $a_n = 0$  and  $a_0 = 0$

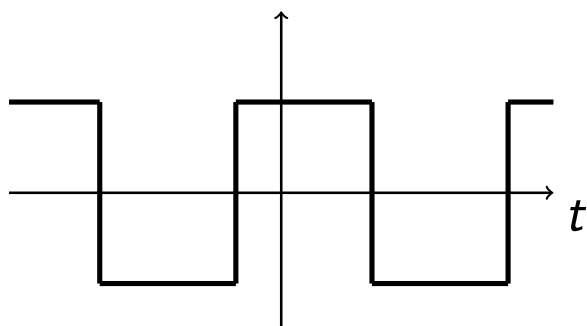

Function with zero mean:  $a_0 = 0$

# Fourier Series: Example 3

Find the Fourier series representation in the range  $-\pi$  to  $\pi$  for the function  $f(t)$  below.

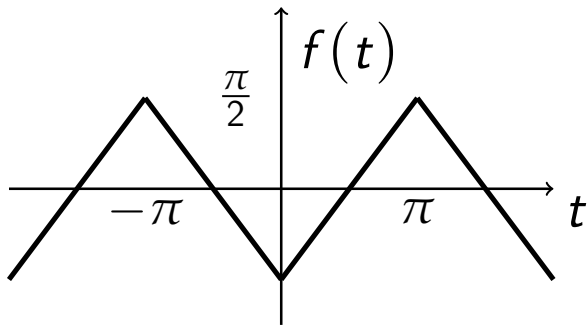

*EVEN* function with zero mean:  $b_n = 0$  and  $a_0 = 0$

We only have to calculate  $a_n$ ,  $n \neq 0$

$$\begin{aligned} a_n &= \frac{1}{\pi} \int_{-\pi}^{\pi} \cos(nt) f(t) dt \\ &= \frac{1}{\pi} \int_{-\pi}^0 \cos(nt) (-t - \pi/2) dt \\ &\quad + \frac{1}{\pi} \int_0^{\pi} \cos(nt) (t - \pi/2) dt \\ &= \frac{2}{\pi} \int_0^{\pi} \cos(nt) (t - \pi/2) dt \\ &= \frac{2}{n^2\pi} ((-1)^n - 1) = \begin{cases} 0 & , n \text{ even} \\ \frac{-4}{n^2\pi} & , n \text{ odd} \end{cases} \end{aligned}$$

so the Fourier series is: 

$$f(t) = \frac{-4}{\pi} \left[ \cos(t) + \frac{1}{9} \cos(3t) + \frac{1}{25} \cos(5t) + \dots \right]$$

# Fourier Series: Example 4

Find the Fourier series representation in the range  $-\pi$  to  $\pi$  for the function  $f(t) = \cos(t + \pi/4)$ .

This function has a mean value of zero so  $a_0 = 0$ .

$$\begin{aligned} a_n &= \frac{1}{\pi} \int_{-\pi}^{\pi} \cos(nt) \cos(t + \pi/4) dt \quad n \neq 0 \\ &= \frac{1}{2\pi} \int_{-\pi}^{\pi} \cos\left(nt + t + \frac{\pi}{4}\right) + \cos\left(nt - t - \frac{\pi}{4}\right) dt \\ &= \frac{1}{\sqrt{2}}, \text{ when } n = 1 \text{ and } 0 \text{ otherwise.} \end{aligned}$$

$$\begin{aligned} b_n &= \frac{1}{\pi} \int_{-\pi}^{\pi} \sin(nt) \cos(t + \pi/4) dt \\ &= \frac{1}{2\pi} \int_{-\pi}^{\pi} \sin\left(nt + t + \frac{\pi}{4}\right) + \sin\left(nt - t - \frac{\pi}{4}\right) dt \\ &= \frac{-1}{\sqrt{2}}, \text{ when } n = 1 \text{ and } 0 \text{ otherwise.} \end{aligned}$$

so the Fourier series is: 

$$f(t) = \frac{\cos(t) - \sin(t)}{\sqrt{2}}$$



# Section 5: Summary

Periodic functions, (so far only with period  $2\pi$ ), can be represented using the Fourier series.

We can use symmetry properties of the function to spot that certain Fourier coefficients will be zero, and hence avoid performing the integral to evaluate them.



- Functions with zero mean have  $a_0 = 0$ .
- Purely odd functions have  $a_n = 0$ .
- Purely even functions have  $b_n = 0$ .

Segments of non-periodic functions can be represented using the Fourier series in the same way. The Fourier series representation just repeats outside the range on which it was built.

# Section 6

## General Fourier Series

The Fourier series for **arbitrary period** is presented.

We compare three techniques for calculating a general range Fourier series: **direct integration**, **using a related series of delta functions**, and **using the Maths Data Book**.

During the direct integration example, some symmetry arguments for simplifying integrals are illustrated.

# General Range

If we want to model a periodic signal with period other than  $2\pi$ , or a section of a non-periodic signal of length other than  $2\pi$  we need a more general formula.

To model a function  $f(x)$  over the range 0 to  $L$ , we choose a variable  $\tilde{x}$  such that  $x/\tilde{x} = L/(2\pi)$ , so that we can substitute  $\tilde{x} = \frac{2\pi}{L}x$ , ( $\Rightarrow dx = \frac{L}{2\pi}d\tilde{x}$ ) in our Fourier formulae (note: taking a range of 0 to  $2\pi$  rather than  $-\pi$  to  $\pi$ ). Expanding our  $f(x)$  as a linear combination of sines and cosines of period  $L$  gives us:

$$f(x) = a_0 + \sum_{n=1}^{\infty} \left[ a_n \cos\left(\frac{2\pi nx}{L}\right) + b_n \sin\left(\frac{2\pi nx}{L}\right) \right]$$

Multiplying by  $\cos\left(\frac{2\pi mx}{L}\right)$  or  $\sin\left(\frac{2\pi mx}{L}\right)$  and integrating from 0 to  $L$ , reduces to our previous equations, giving:

$$a_n = \frac{2}{L} \int_0^L \cos\left(\frac{2\pi nx}{L}\right) f(x) dx$$

$$b_n = \frac{2}{L} \int_0^L \sin\left(\frac{2\pi nx}{L}\right) f(x) dx$$

$$a_0 = \frac{1}{L} \int_0^L f(x) dx$$

The fraction  $\frac{2\pi}{L}$  is often written as  $\omega_0$  and called the  **fundamental angular frequency**.

# General Range Example 1

Represent the signal  $f(x) = x(1 - x)$  as a Fourier series with period 1, based on the range 0 to 1.

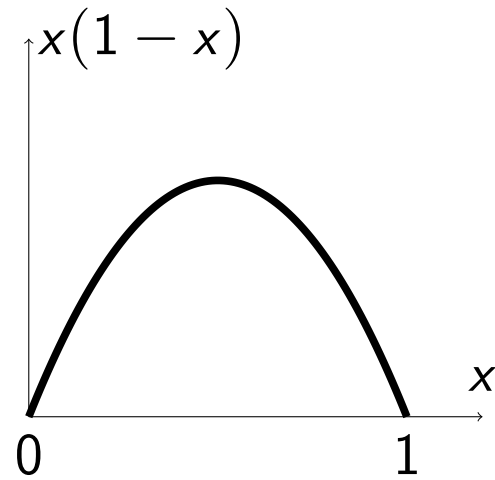

$$a_n = 2 \int_0^1 \cos(2\pi nx) x(1-x) dx = -\frac{1}{n^2 \pi^2}$$

$$b_n = 2 \int_0^1 \sin(2\pi nx) x(1-x) dx = 0$$

$$a_0 = \int_0^1 x(1-x) dx = \frac{1}{6}$$

So the Fourier series is:

$$f(x) = \frac{1}{6} - \frac{\cos(2\pi x)}{\pi^2} - \frac{\cos(4\pi x)}{4\pi^2} - \frac{\cos(6\pi x)}{9\pi^2} - \dots$$

➤ Note that this is an even function with period = 1.

# General Range Example 2

Represent the signal  $f(x) = \delta(x - L/4) - \delta(x - 3L/4)$  as a Fourier series based on the range 0 to  $L$ .

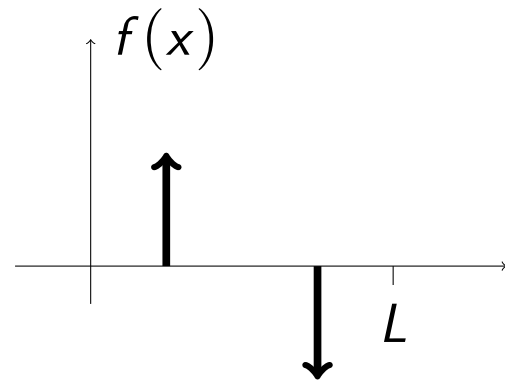

We are told that the period is  $L$ , so consider the signal repeating with period  $L$ .

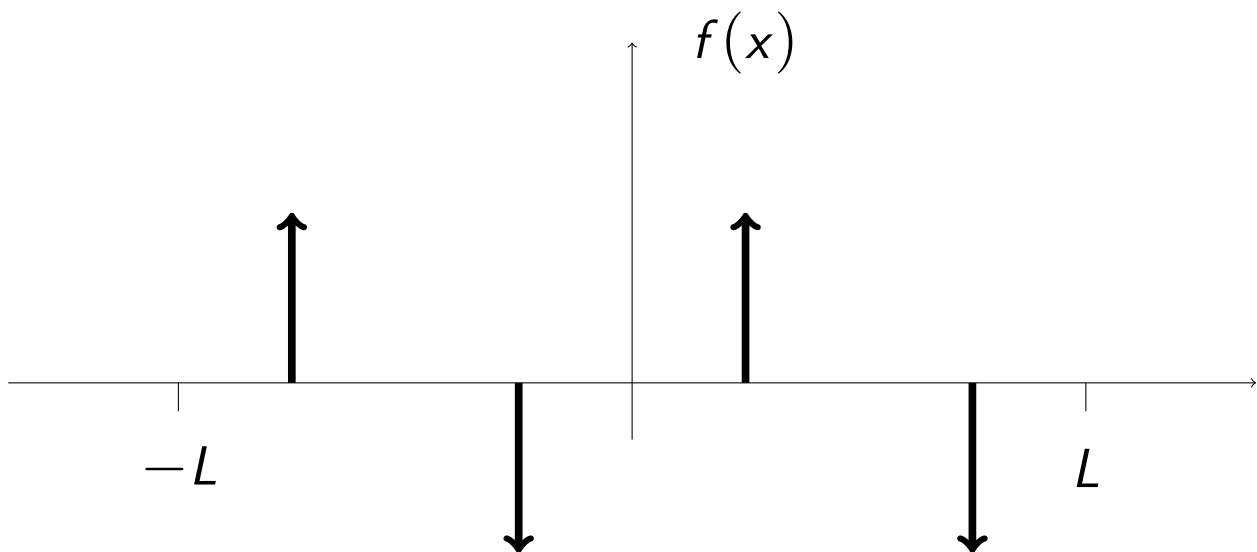

This signal is purely ODD with zero mean. We therefore only need to calculate  $b_n$ .



$$\begin{aligned} b_n &= \frac{2}{L} \int_0^L \sin\left(\frac{2\pi nx}{L}\right) f(x) dx \\ &= \frac{2}{L} \int_0^L \sin\left(\frac{2\pi nx}{L}\right) \left[ \delta\left(x - \frac{L}{4}\right) - \delta\left(x - \frac{3L}{4}\right) \right] dx \\ &= \frac{2}{L} \left[ \sin\left(\frac{2\pi nL}{4L}\right) - \sin\left(\frac{6\pi nL}{4L}\right) \right] \quad (\text{sifting!}) \\ &= \frac{2}{L} \left[ \sin\left(\frac{n\pi}{2}\right) - \sin\left(\frac{3n\pi}{2}\right) \right] \\ &= \frac{4}{L} \sin\left(\frac{n\pi}{2}\right) \end{aligned}$$

$$b_n = \frac{4}{L} \sin\left(\frac{n\pi}{2}\right)$$

This is zero when  $n$  is even. Tabulate  $\sin\left(\frac{n\pi}{2}\right)$  when  $n$  is odd.



$\sin\left(\frac{n\pi}{2}\right)$	$n$	$\frac{n+1}{2}$	$-1^{\left(\frac{n+1}{2}\right)}$	$\frac{n+3}{2}$	$-1^{\left(\frac{n+3}{2}\right)}$
1	1	1	-1	2	1
-1	3	2	1	3	-1
1	5	3	-1	4	1
-1	7	4	1	5	-1

Thus

$$b_n = \begin{cases} 0 & n \text{ even} \\ \frac{4}{L}(-1)^{\left(\frac{n+3}{2}\right)} & n \text{ odd} \end{cases}$$

So the Fourier series is:

$$f(x) = \frac{4}{L} \left[ \sin\left(\frac{2\pi x}{L}\right) - \sin\left(\frac{6\pi x}{L}\right) + \sin\left(\frac{10\pi x}{L}\right) - \dots \right]$$

# More Integral Avoidance

Notice how easy it is to calculate the Fourier series of a signal formed only of delta functions. By integrating the delta function series we can derive the Fourier series for square waves and triangle waves.

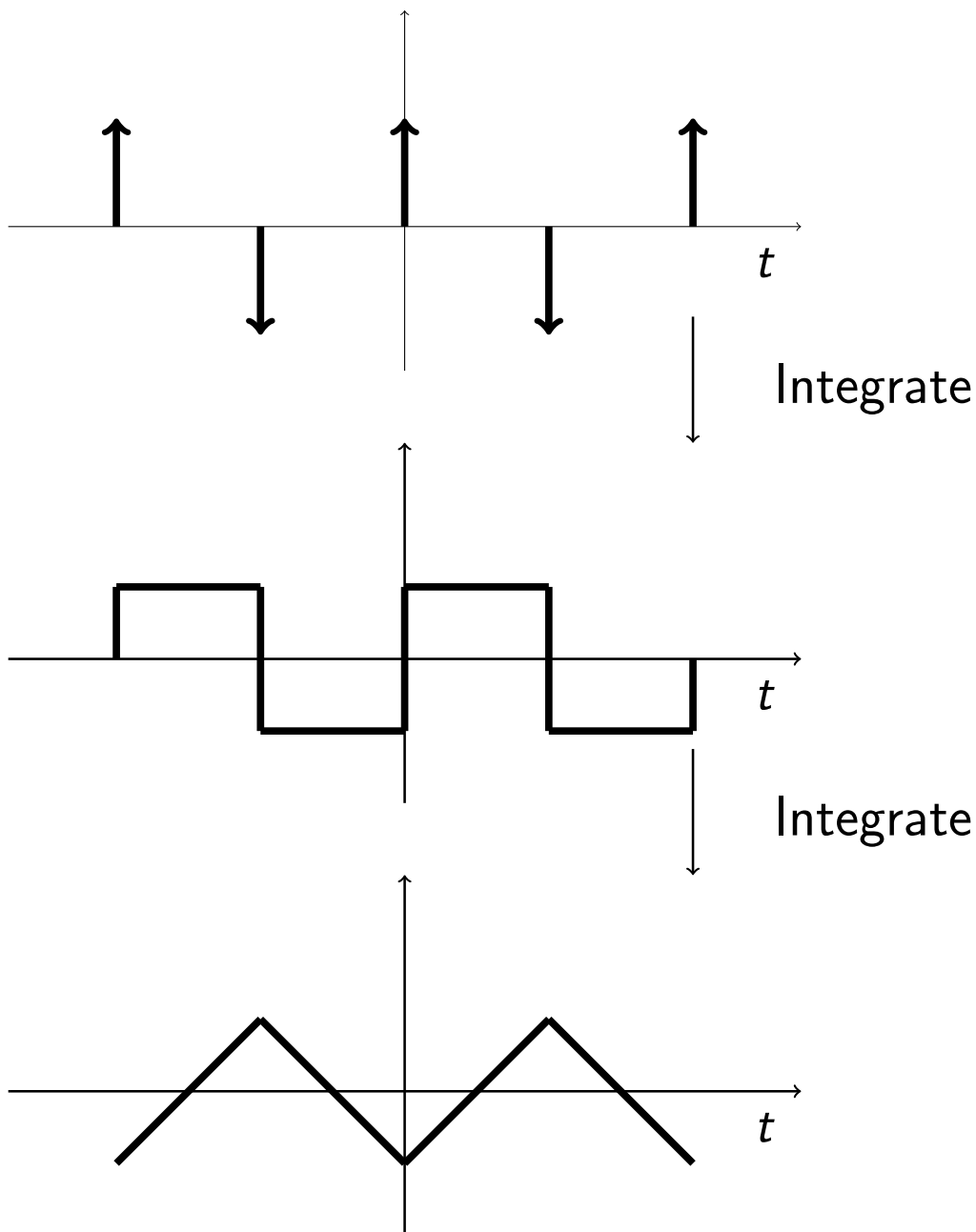



# Pick the Start of the Period Carefully

If you wish to find the Fourier series of a waveform such as

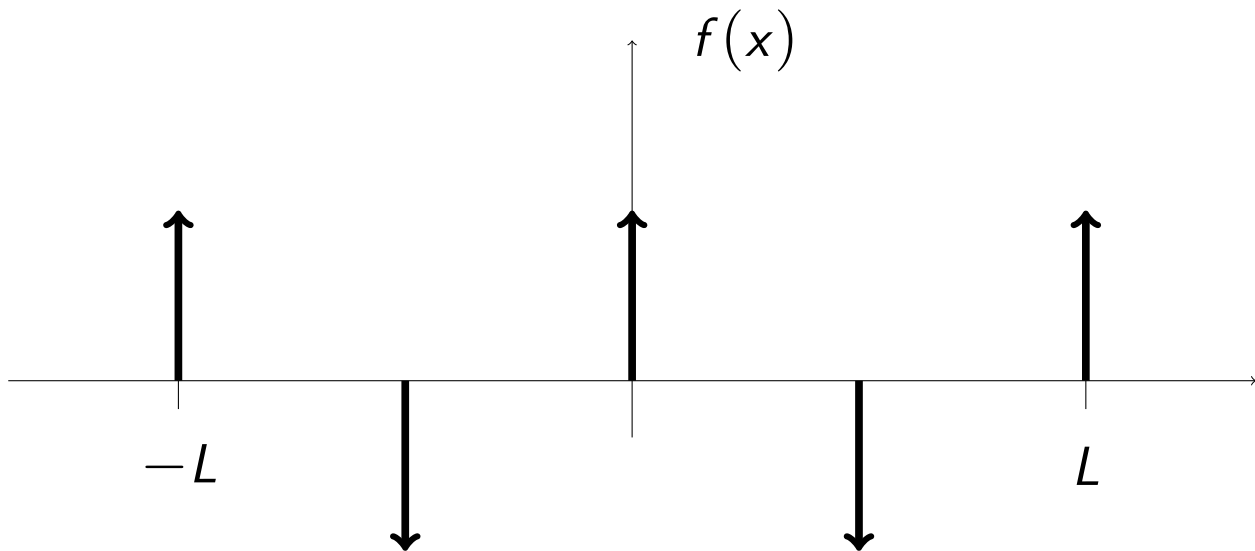

it is difficult to use formulae with limits such as

$$a_n = \frac{2}{L} \int_0^L \cos\left(\frac{2\pi nx}{L}\right) f(x) dx$$

because it is not clear what to do about the delta functions that coincide with the upper or lower limits of the integral.

Instead, choose your period of length  $L$  to start at a different point. For example:

$$a_n = \frac{2}{L} \int_{-\frac{L}{4}}^{\frac{3L}{4}} \cos\left(\frac{2\pi nx}{L}\right) f(x) dx$$

# Three Methods

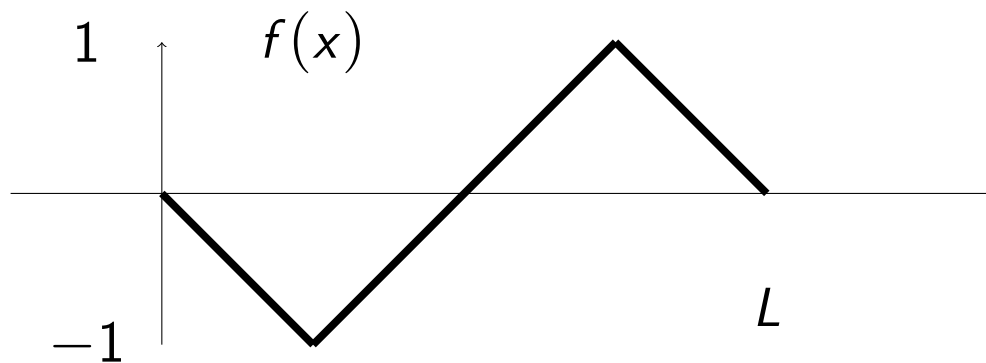

There are three ways to find the Fourier series for  $f(x)$  between  $0$  and  $L$ .

1. Use the general range Fourier formulae directly.
2. Differentiate the waveform twice to get a sequence of delta functions. Find a Fourier series for the delta functions, then integrate the series twice to get the Fourier series of the triangular wave.
3. Look up the Fourier series of a similar waveform in the Maths Data book and use a substitution of variables to find the series for the waveform we require.

# Method 1: Direct Integration

The triangular waveform is entirely ODD and has zero mean. Thus  $a_0 = 0$  and  $a_n = 0$ . We only need to find  $b_n$ .

To do this we need an algebraic representation of the waveform.

$$f(x) = \begin{cases} -\frac{4x}{L} & , 0 < x < \frac{L}{4} \\ \frac{4x}{L} - 2 & , \frac{L}{4} < x < \frac{3L}{4} \\ 4 - \frac{4x}{L} & , \frac{3L}{4} < x < L \end{cases}$$

From this we can write down an expression for  $b_n$ . 

$$b_n = \frac{2}{L} \int_0^L \sin\left(\frac{2\pi nx}{L}\right) f(x) dx$$

$$= \frac{2}{L} \int_0^{\frac{L}{4}} \sin\left(\frac{2\pi nx}{L}\right) \left(\frac{-4x}{L}\right) dx \quad (1)$$

$$+ \frac{2}{L} \int_{\frac{L}{4}}^{\frac{3L}{4}} \sin\left(\frac{2\pi nx}{L}\right) \left(\frac{4x}{L} - 2\right) dx \quad (2)$$

$$+ \frac{2}{L} \int_{\frac{3L}{4}}^L \sin\left(\frac{2\pi nx}{L}\right) \left(4 - \frac{4x}{L}\right) dx \quad (3)$$

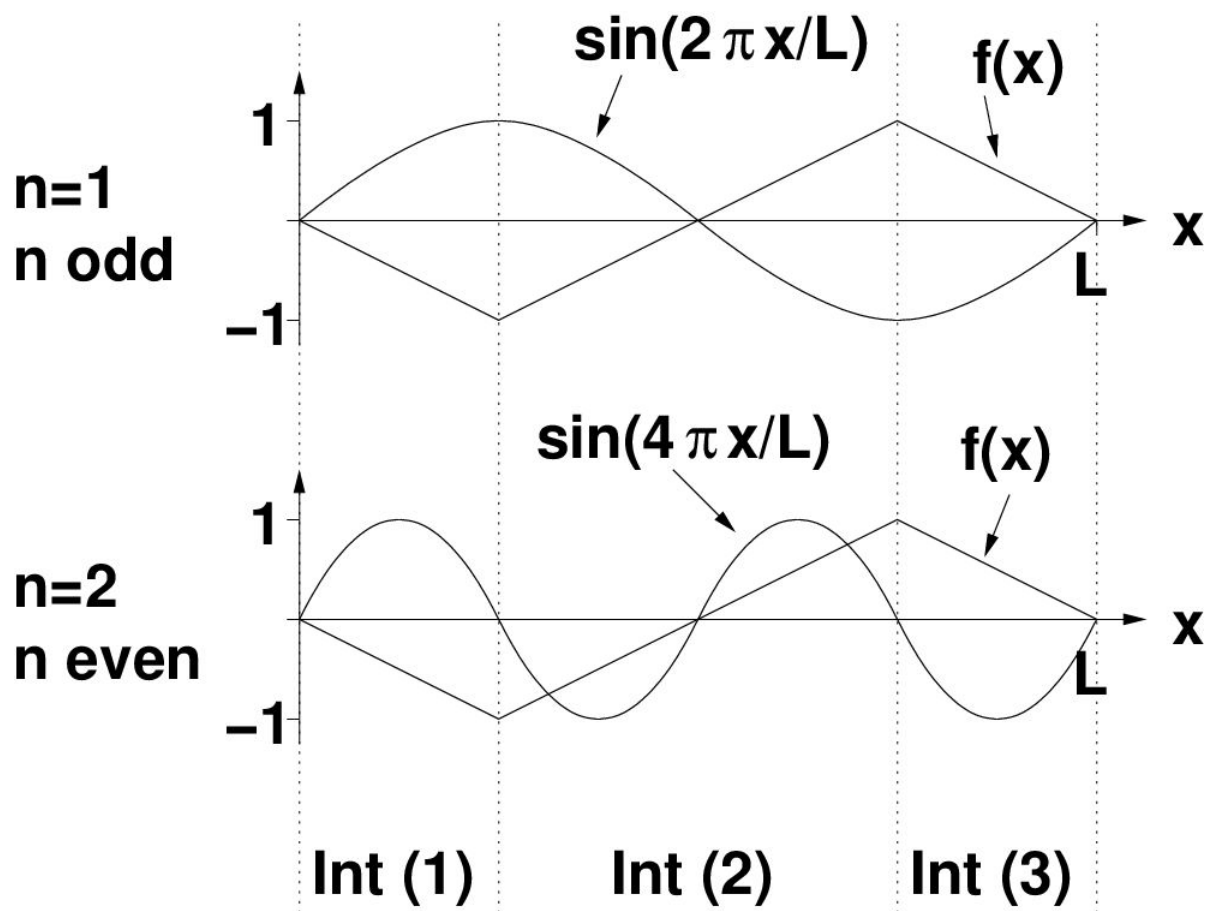

There is clearly a symmetry between the terms  $f(x)$  and  $\sin\left(\frac{2\pi nx}{L}\right)$  [consider even or odd behaviour of  $\sin\left(\frac{2\pi nx}{L}\right) f(x)$  about  $L/2$  and  $L/4$ ].

All terms with even  $n$  are zero, and all terms with odd  $n$  are equal to twice integral (2) or four times integral (1).

Therefore, when  $n$  is even  $b_n = 0$ , and when  $n$  is odd we can simplify our calculation by, for example, calculating  $4 \times$  integral 1, to give:

$$b_n = \frac{8}{n^2 \pi^2} \left( \frac{n\pi}{2} \cos \left( \frac{n\pi}{2} \right) - \sin \left( \frac{n\pi}{2} \right) \right)$$

But as we know  $n$  is odd, the  $\cos()$  term is always zero and we can write  $\left[ -\sin \left( \frac{n\pi}{2} \right) \right] = (-1)^{\left( \frac{n+1}{2} \right)}$



$$\Rightarrow b_n = \begin{cases} 0, & n \text{ even} \\ \frac{8}{n^2 \pi^2} \times (-1)^{\left( \frac{n+1}{2} \right)} & n \text{ odd} \end{cases}$$

Giving a final Fourier series for  $f(x) =$

$$\frac{8}{\pi^2} \left[ -\sin \left( \frac{2\pi x}{L} \right) + \frac{\sin \left( \frac{2\pi 3x}{L} \right)}{9} - \frac{\sin \left( \frac{2\pi 5x}{L} \right)}{25} + \dots \right]$$

If we want to write this algebraically, we need to limit  $n$  to only odd values. Let  $n = 2m - 1$  with  $m$  taking integer values from 1 to  $\infty$ .

$$f(x) = \frac{8}{\pi^2} \sum_{m=1}^{\infty} \frac{(-1)^m}{(2m-1)^2} \sin \left( \frac{2\pi x(2m-1)}{L} \right)$$

# A brief aside on delta functions

Reminder of what we should already know:

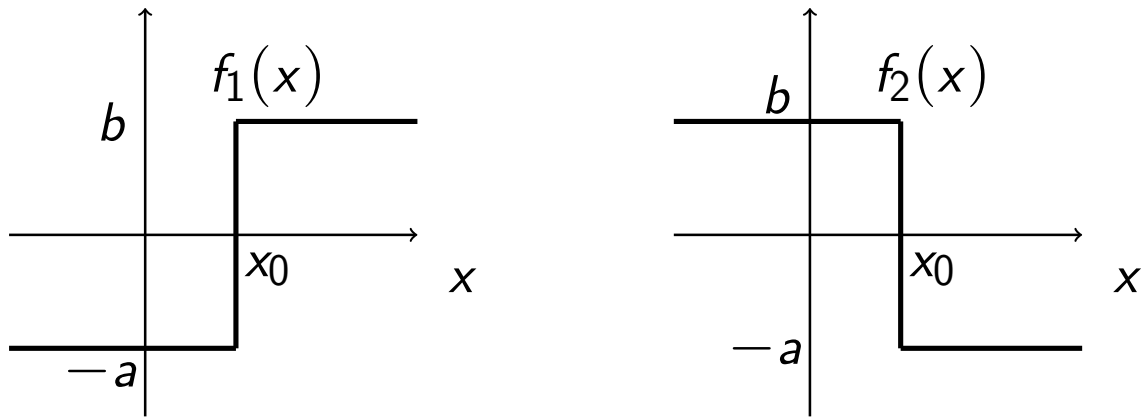

For  $f_1(x)$ :  $f_1'(x) = 0$  for  $x > x_0$  and  $x < x_0$ , and similarly for  $f_2'(x)$ .

Also we have that

$$\int_{x_0-\epsilon}^{x_0+\epsilon} f_1'(x) dx = [f_1(x)]_{x_0-\epsilon}^{x_0+\epsilon} = [b - (-a)] = a + b$$

and

$$\int_{x_0-\epsilon}^{x_0+\epsilon} f_2'(x) dx = [f_2(x)]_{x_0-\epsilon}^{x_0+\epsilon} = [-a - b] = -(a + b)$$

Thus we have that:

$$f_1'(x) = (a + b)\delta(x - x_0) \quad \text{and} \quad f_2'(x) = -(a + b)\delta(x - x_0)$$

# Method 2: Delta Functions

First we differentiate the waveform twice.

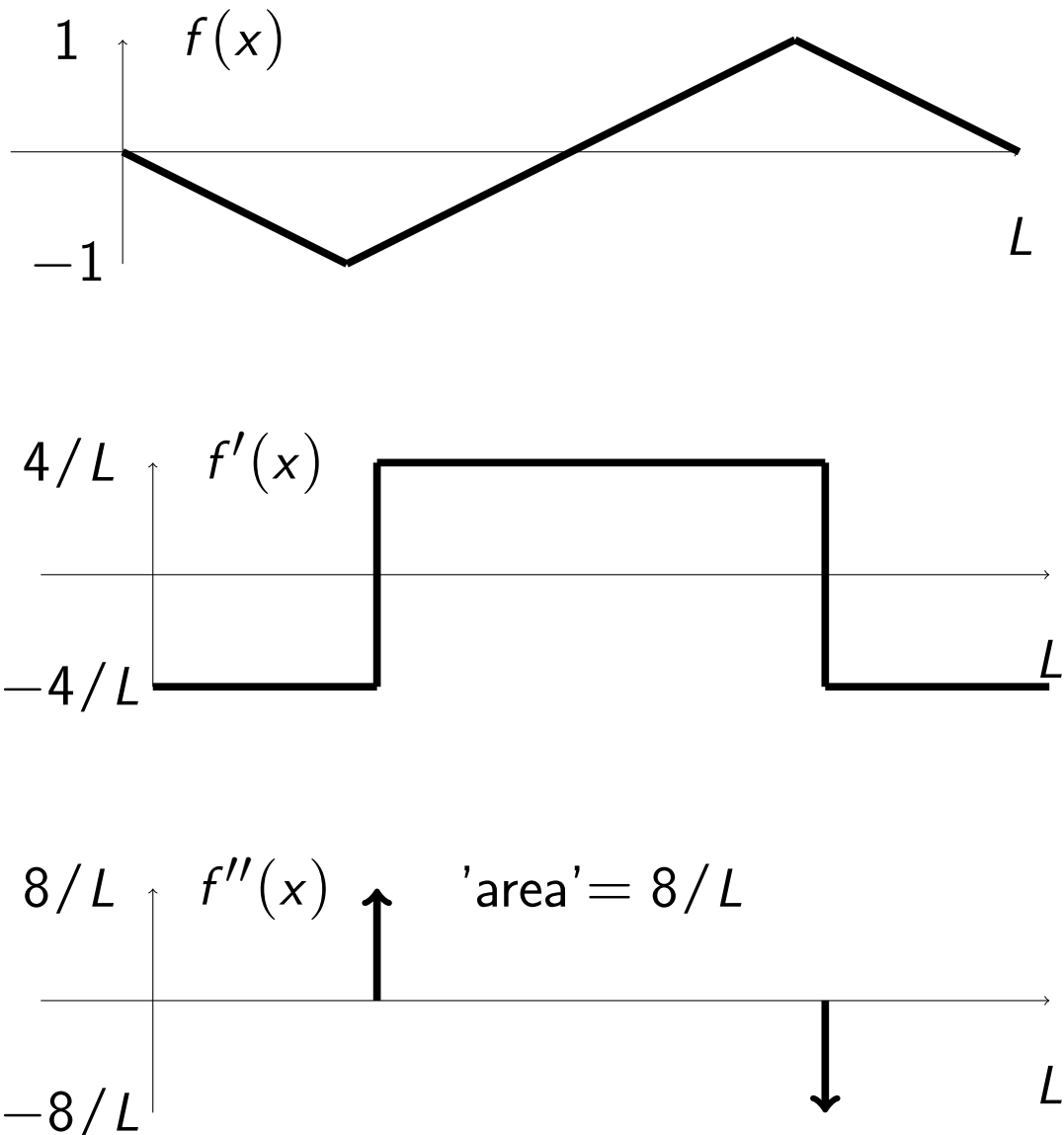

$f''(x)$  is a purely odd function with zero mean so we only need to calculate  $b_n$ .

$$f''(x) = \frac{8}{L} \delta \left( x - \frac{L}{4} \right) - \frac{8}{L} \delta \left( x - \frac{3L}{4} \right)$$

To find the Fourier series for  $f''(x)$ :



$$\begin{aligned}
 b_n &= \frac{2}{L} \int_0^L \sin\left(\frac{2\pi nx}{L}\right) f(x) dx \\
 &= \frac{16}{L^2} \int_0^L \sin\left(\frac{2\pi nx}{L}\right) \left[ \delta\left(x - \frac{L}{4}\right) - \delta\left(x - \frac{3L}{4}\right) \right] dx \\
 &= \frac{16}{L^2} \left[ \sin\left(\frac{2\pi nL}{4L}\right) - \sin\left(\frac{6\pi nL}{4L}\right) \right] \quad (\text{sifting!}) \\
 &= \begin{cases} 0 & n \text{ even} \\ \frac{32}{L^2} (-1)^{\left(\frac{n+3}{2}\right)} & n \text{ odd} \end{cases}
 \end{aligned}$$

So the Fourier series for  $f''(x) =$

$$\frac{32}{L^2} \left[ \sin\left(\frac{2\pi x}{L}\right) - \sin\left(\frac{6\pi x}{L}\right) + \sin\left(\frac{10\pi x}{L}\right) - \dots \right]$$

We can also write this (note that  $2m - 1 = n$ ) as

$$f''(x) = \frac{32}{L^2} \sum_{m=1}^{\infty} (-1)^{m+1} \sin\left(\frac{2\pi x(2m-1)}{L}\right)$$



Now we integrate twice, each time setting the constant of integration to zero so we get a waveform with zero mean in each case.

$$f''(x) = \frac{32}{L^2} \sum_{m=1}^{\infty} \sin\left(\frac{2\pi x(2m-1)}{L}\right) (-1)^{m+1}$$

$$f'(x) = \frac{16}{\pi L} \sum_{m=1}^{\infty} \frac{\cos\left(\frac{2\pi x(2m-1)}{L}\right)}{2m-1} (-1)^m$$

$$f(x) = \frac{8}{\pi^2} \sum_{m=1}^{\infty} \frac{\sin\left(\frac{2\pi x(2m-1)}{L}\right)}{(2m-1)^2} (-1)^m$$

Which we can write out as follows  $f(x) =$  

$$\frac{8}{\pi^2} \left[ -\sin\left(\frac{2\pi x}{L}\right) + \frac{\sin\left(\frac{2\pi 3x}{L}\right)}{9} - \frac{\sin\left(\frac{2\pi 5x}{L}\right)}{25} + \dots \right]$$

# Method 3: Maths Databook

Only works if something like the desired function is in the maths data book! 

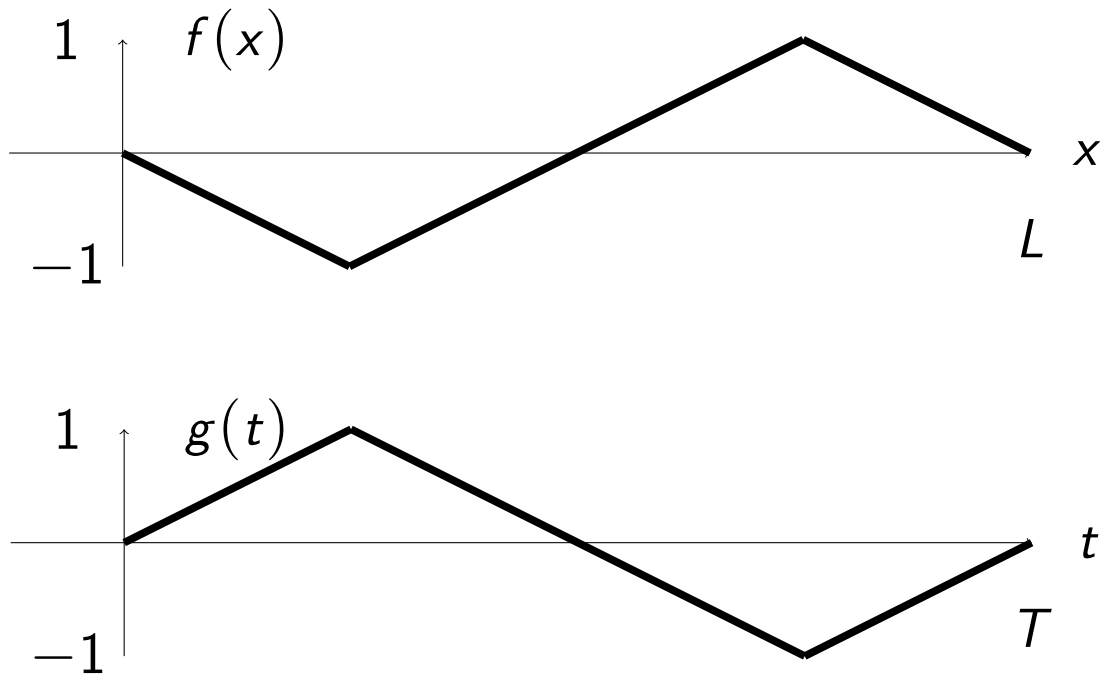

In this case we want  $f(x)$  as above, and the nearest available series is  $g(t)$ .

$$g(t) = \frac{8}{\pi^2} \sum_{n=1}^{\infty} (-1)^{n+1} \frac{\sin([2n-1]\omega_0 t)}{(2n-1)^2}$$

where  $\omega_0 = 2\pi/T$ .

If we set  $x = t$  and  $L = T$  then  $f = -g$ .

$$\begin{aligned}\Rightarrow f(x) &= \frac{8}{\pi^2} \sum_{n=1}^{\infty} \frac{\sin([2n-1]\omega_0 x)}{(2n-1)^2} (-1)^n \\ &= \frac{8}{\pi^2} \sum_{n=1}^{\infty} \frac{\sin\left(\frac{2\pi x(2n-1)}{L}\right)}{(2n-1)^2} (-1)^n\end{aligned}$$

Which we can write out, as with the other methods, as follows  $f(x) =$  

$$\frac{8}{\pi^2} \left[ -\sin\left(\frac{2\pi x}{L}\right) + \frac{\sin\left(\frac{2\pi 3x}{L}\right)}{9} - \frac{\sin\left(\frac{2\pi 5x}{L}\right)}{25} + \dots \right]$$

# Section 6: Summary



$$a_n = \frac{2}{L} \int_{\alpha}^{L+\alpha} \cos\left(\frac{2\pi nx}{L}\right) f(x) dx$$

$$b_n = \frac{2}{L} \int_{\alpha}^{L+\alpha} \sin\left(\frac{2\pi nx}{L}\right) f(x) dx$$

$$a_0 = \frac{1}{L} \int_{\alpha}^{L+\alpha} f(x) dx$$

$$f(x) = a_0 + \sum_{n=1}^{\infty} \left[ a_n \cos\left(\frac{2\pi nx}{L}\right) + b_n \sin\left(\frac{2\pi nx}{L}\right) \right]$$

for any  $\alpha$ .

You can sometimes combine multiple integrals using symmetry properties.

Sometimes it is faster to calculate a related Fourier series of delta functions and integrate.

Don't forget the Fourier series given in the Maths Databook.

Note: it is probably more convenient to write (as the Maths Databook does!)  $\omega_0 = 2\pi/L$  so that our equations for the Fourier coefficients and Fourier Series become:

$$a_n = \frac{2}{L} \int_{\alpha}^{L+\alpha} \cos(\omega_0 n x) f(x) dx$$

$$b_n = \frac{2}{L} \int_{\alpha}^{L+\alpha} \sin(\omega_0 n x) f(x) dx$$

$$a_0 = \frac{1}{L} \int_{\alpha}^{L+\alpha} f(x) dx$$

$$f(x) = a_0 + \sum_{n=1}^{\infty} [a_n \cos(\omega_0 n x) + b_n \sin(\omega_0 n x)]$$

for any  $\alpha$ .

# Databook Fourier Series 1

**Half-wave rectified cosine wave:**

$$f(t) = \frac{1}{\pi} + \frac{1}{2} \cos \omega_0 t + \frac{2}{\pi} \sum_{m=1}^{\infty} (-1)^{m+1} \frac{\cos(2m\omega_0 t)}{4m^2 - 1}$$

$$f(t) = \frac{1}{\pi} + \frac{1}{4} e^{i\omega_0 t} + \frac{1}{4} e^{-i\omega_0 t} + \frac{1}{\pi} \sum_{\substack{n=-\infty \\ n \text{ even} \\ n \neq 0}}^{\infty} (\pm 1) \frac{e^{in\omega_0 t}}{n^2 - 1}$$

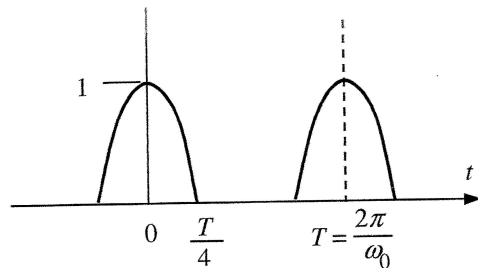

signs alternate, + for  $n = 2$

**$p$ -phase rectified cosine wave ( $p \geq 2$ ):**

$$f(t) = \frac{p}{\pi} \sin \frac{\pi}{p} \left[ 1 + 2 \sum_{m=1}^{\infty} (-1)^{m+1} \frac{\cos(pm\omega_0 t)}{p^2 m^2 - 1} \right]$$

$$f(t) = \frac{p}{\pi} \sin \frac{\pi}{p} \left[ 1 + \frac{1}{\pi} \sum_{\substack{n=-\infty \\ n \text{ multiple} \\ \text{of } p}}^{\infty} (\pm 1) \frac{e^{in\omega_0 t}}{n^2 - 1} \right]$$

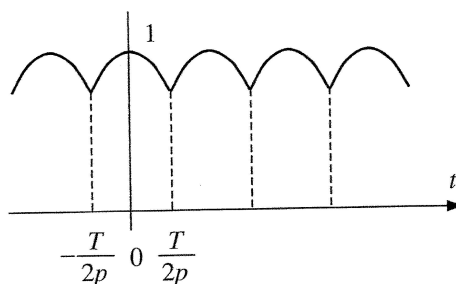

signs alternate, + for  $n = p$

**Square wave:**

$$f(t) = \frac{4}{\pi} \sum_{m=1}^{\infty} \frac{\sin(2m-1)\omega_0 t}{2m-1}$$

$$f(t) = \sum_{\substack{n=-\infty \\ n \text{ odd} \\ n \neq 0}}^{\infty} \frac{2}{i\pi n} e^{in\omega_0 t}$$

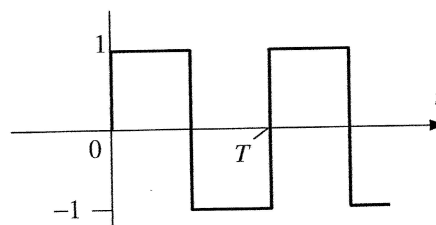

**Triangular wave:**

$$f(t) = \frac{8}{\pi^2} \sum_{m=1}^{\infty} (-1)^{m+1} \frac{\sin(2m-1)\omega_0 t}{(2m-1)^2}$$

$$f(t) = \frac{4}{i\pi^2} \sum_{\substack{n=-\infty \\ n \text{ odd}}}^{\infty} (\pm 1) \frac{e^{in\omega_0 t}}{n^2}$$

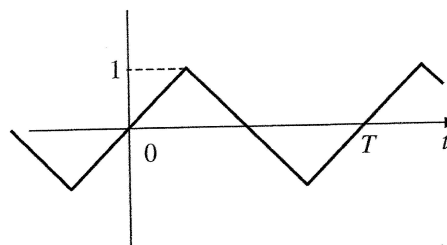

signs alternate, + for  $n = 1$

# Databook Fourier Series 2

**Saw-tooth wave:**

$$f(t) = \frac{2}{\pi} \sum_{n=1}^{\infty} (-1)^{n+1} \frac{\sin n\omega_0 t}{n}$$

$$f(t) = \frac{1}{i\pi} \sum_{\substack{n=-\infty \\ n \neq 0}}^{\infty} (\pm 1) \frac{e^{in\omega_0 t}}{n}$$

signs alternate, + for  $n = 1$

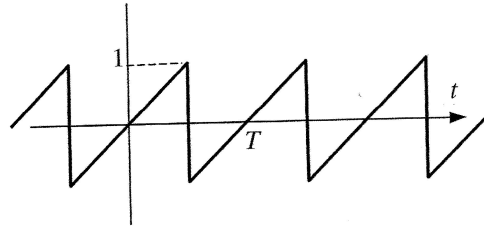

**Pulse wave:**

$$f(t) = \frac{a}{T} \left[ 1 + 2 \sum_{n=1}^{\infty} \frac{\sin \frac{n\pi a}{T}}{\frac{n\pi a}{T}} \cos(n\omega_0 t) \right]$$

$$f(t) = \frac{a}{T} \left[ 1 + \sum_{\substack{n=-\infty \\ n \neq 0}}^{\infty} \frac{\sin \frac{n\pi a}{T}}{\frac{n\pi a}{T}} e^{in\omega_0 t} \right]$$

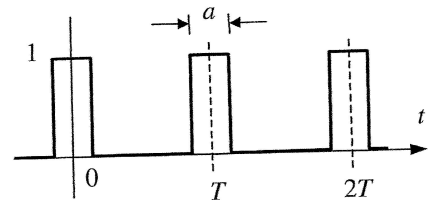

## 16. Fourier Transforms

$$\hat{y}(\omega) = \int_{-\infty}^{\infty} y(t) e^{-i\omega t} dt \quad : \quad y(t) = \int_{-\infty}^{\infty} \hat{y}(\omega) e^{i\omega t} \frac{d\omega}{2\pi}$$

- Caution -
- (a) Fourier transforms are sometimes written in terms of frequency  $f = \omega/2\pi$
  - (b) Some books handle the  $2\pi$  factor differently and define transforms with differences in signs of the exponent

# Section 7

## Convergence and Half-Range Series

The rule for predicting the convergence of the Fourier series from the shape of the function is introduced.

This is used with the Fourier series for general period to calculate series, valid over limited ranges, with improved convergence properties. Four different series are calculated to model the same simple function in order to illustrate this.

The usefulness of Matlab and Octave for numerical calculation, and the use of Matlab for symbolic algebra are introduced.



# General Range Example 3

Following on from Section 6....

An even function  $f(t)$  is periodic with period  $T = 2$ , and  $f(t) = \cosh(t - 1)$  for  $0 \leq t \leq 1$ . Sketch  $f(t)$  in the range  $-2 \leq t \leq 4$ . Find a Fourier series representation for  $f(t)$ .

First remember what the graph of  $\cosh(t)$  looks like. 

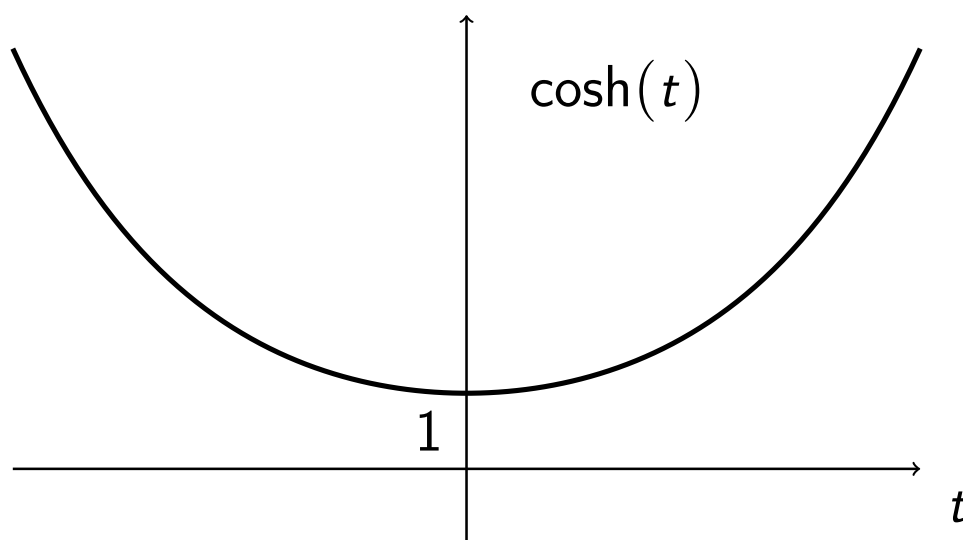

Now plot the finite shifted cosh as a periodic function:

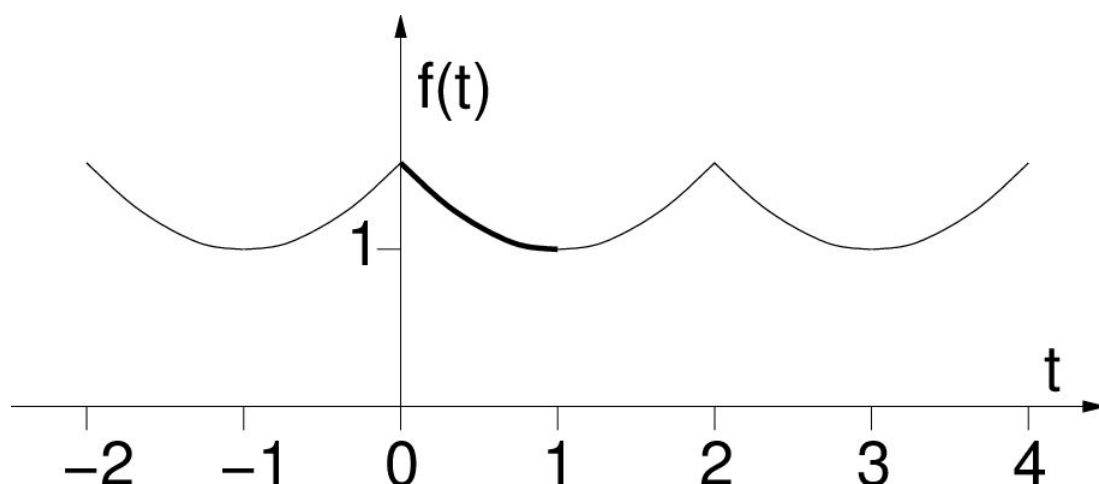

It is an even function  $\Rightarrow b_n = 0$  and  $a_n \neq 0$ .

The mean value of the function is non-zero  $\Rightarrow a_0 \neq 0$ .

$$\begin{aligned}
 a_n &= \frac{2}{T} \int_{-1}^1 f(t) \cos\left(\frac{2\pi nt}{T}\right) dt \\
 &= \frac{4}{T} \int_0^1 f(t) \cos\left(\frac{2\pi nt}{T}\right) dt \\
 &= 2 \int_0^1 \cosh(t-1) \cos(n\pi t) dt \quad (T = 2) \\
 &= \frac{2 \sinh(1)}{1 + n^2 \pi^2}
 \end{aligned}$$

[solve via integration by parts to form  $I = \alpha + \beta I$ , where  $I$  is our integral].

$$\begin{aligned} a_0 &= \frac{1}{T} \int_{-1}^1 f(t) dt = \frac{2}{T} \int_0^1 f(t) dt \\ &= \int_0^1 \cosh(t-1) dt = \sinh(1) \end{aligned}$$

So 

$$\begin{aligned} f(t) &= a_0 + \sum_{n=1}^{\infty} a_n \cos\left(\frac{2\pi nx}{L}\right) \\ &= \sinh(1) \left[ 1 + 2 \sum_{n=1}^{\infty} \frac{\cos(n\pi t)}{1 + n^2\pi^2} \right] \end{aligned}$$

# Square Wave Series Convergence

The graphs below show the sum of 1, 2, 3 ... up to 9 terms of the Fourier series for a square wave.

$$\text{Recall } f(t) = \frac{4}{\pi} \left[ \sin(t) + \frac{\sin(3t)}{3} + \frac{\sin(5t)}{5} + \dots \right]$$

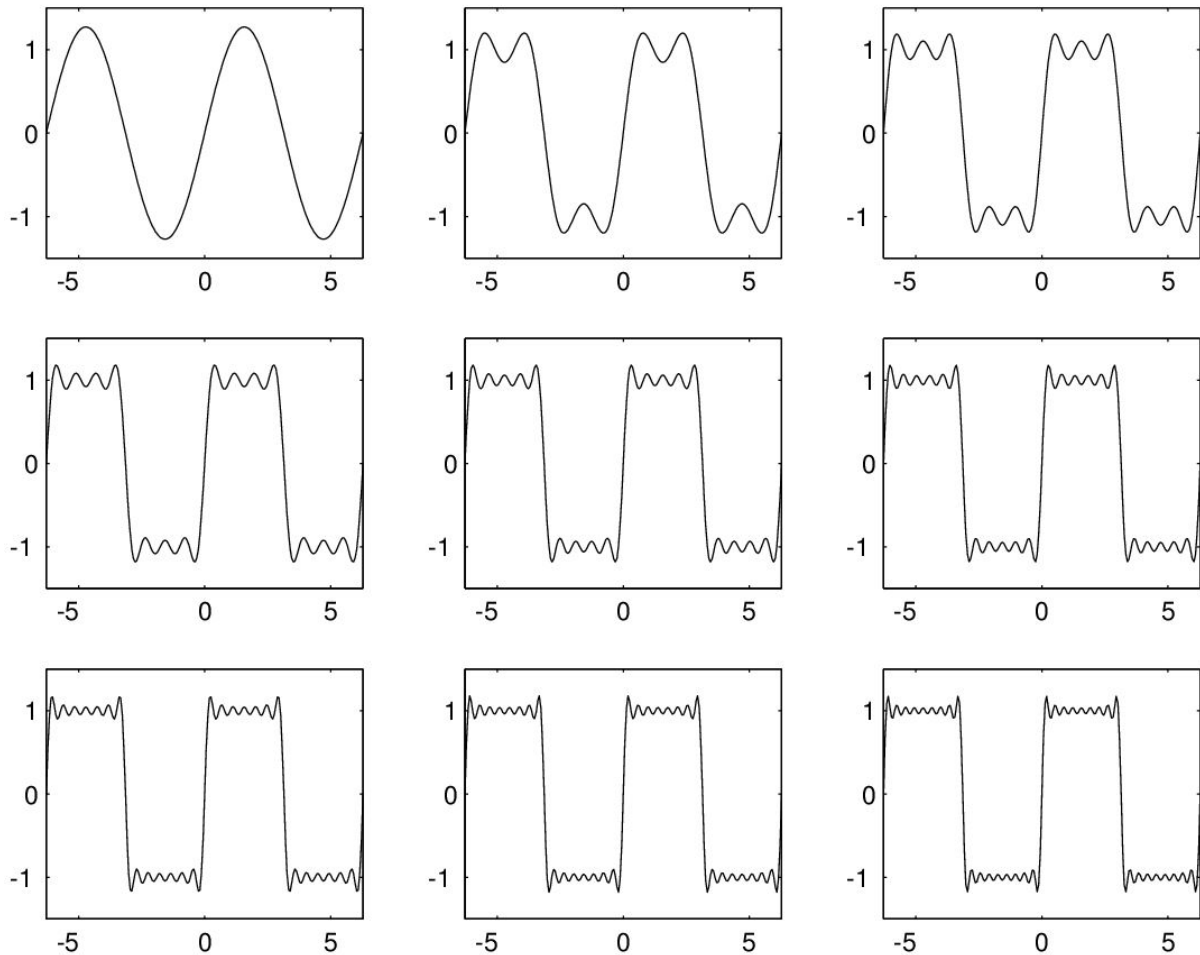

# Using Matlab/Octave

```
% Fourier series for square wave
number = 200;
dtheta = 4*pi/number;
theta = -2*pi:dtheta:2*pi;
nharm = 20;

a0 = 0;
thing = a0 * ones(1,number+1);
for n=1:nharm
    if mod(n,2) == 1
        bn = 4/(pi*n);
    else
        bn = 0;
    end
    an = 0;
    thing = thing + an * cos(n*theta) ...
            + bn * sin(n*theta);
    plot(theta,thing);
    axis([-2*pi 2*pi -1.5 1.5]);
    pause(1)
end
```

```
theta = -2*pi:dtheta:2*pi;
```

sets up `theta` as an array with 201 elements, starting at  $-2\pi$ , going up to  $2\pi$ , with spacing  $dtheta = 4\pi/200$ .

```
    -6.2832, -6.2204, ...      ... 6.2204, 6.2832
```

```
thing = a0 * ones(1,number+1);
```

initialises the 201 element array in which we hold the value of the series at each angle. The initial value of each element is `a0`, which in this case is zero.

```
for n=1:nharm
```

This introduces a `for` loop. We go round the loop `nharm` times to add in `nharm` harmonics.

```
thing = thing + an * cos(n*theta) ...  
          + bn * sin(n*theta);
```

This statement works on every element of the `theta` array, calculating the terms of the `cos` and `sin` series and adding them in to the appropriate sums in the `thing` array.

# Using Matlab Symbolic Tools

Both convolution and Fourier work involves a lot of integration. Sometimes it is nice to know what the right answer is, so you can check your working. To integrate  $p$  with respect to  $x$  from  $a$  to  $b$  you use the command `int(p, x, a, b)`. Consider the integral:

$$\frac{2}{T} \int_0^T \cos\left(\frac{2\pi nx}{T}\right) x dx = 0$$

```
>> syms n x T
>> int((2/T)*x*cos(2*pi*n*x/T),x,0,T)
```

```
ans =
T*(cos(pi*n)^2-1
+2*pi*n*sin(pi*n)*cos(pi*n))/pi^2/n^2
```

which is

$$\frac{T \left( (\cos(\pi n))^2 - 1 + 2\pi n \sin(\pi n) \cos(\pi n) \right)}{\pi^2 n^2}$$

But as  $n$  is an integer,  $\cos^2(n\pi) = 1$  and  $\sin(n\pi) = 0$ , so the integral evaluates to zero.

Don't rely on this too much. You need to be able to integrate efficiently by hand in the exam.

# Convergence Examples

The Fourier series for a square wave converges as  $1/n$ . Note that the function itself is discontinuous.

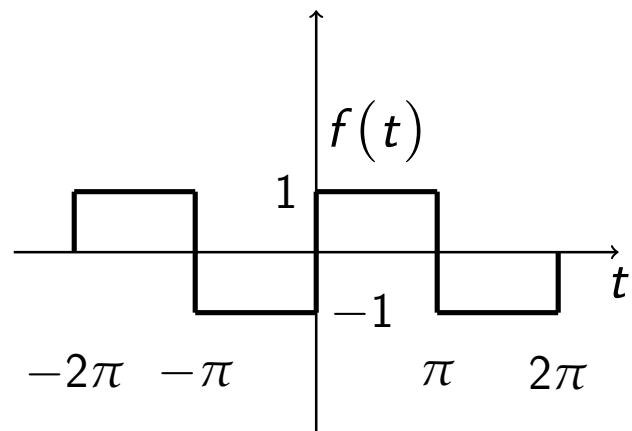

$$f(t) = \frac{4}{\pi} \left[ \sin(t) + \frac{\sin(3t)}{3} + \frac{\sin(5t)}{5} + \dots \right]$$

The Fourier series for a triangular wave converges as  $1/n^2$ . Here the function is continuous, but its gradient is discontinuous.

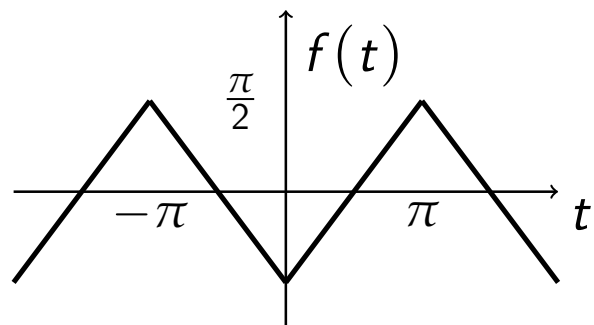

$$F(t) = \frac{-4}{\pi} \left[ \cos(t) + \frac{\cos(3t)}{9} + \frac{\cos(5t)}{25} + \dots \right]$$



# Convergence



integrate

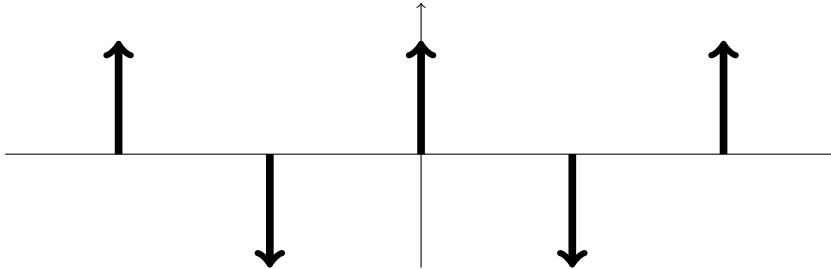

Series for  
delta functions  
does not converge

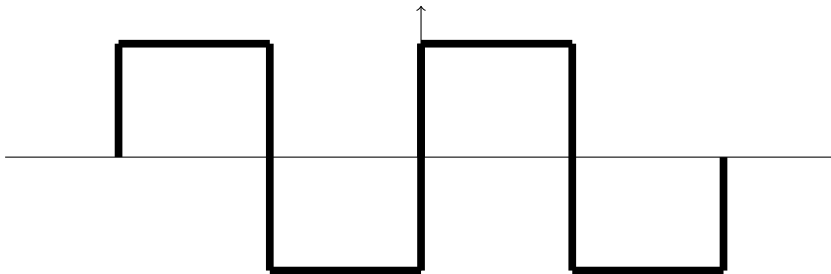

Discontinuities  $\Rightarrow$   
converges as  $1/n$

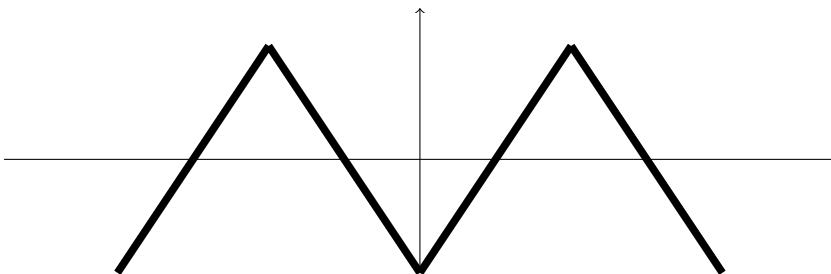

Discontinuous  
gradient  $\Rightarrow$   
converges as  $1/n^2$

differentiate

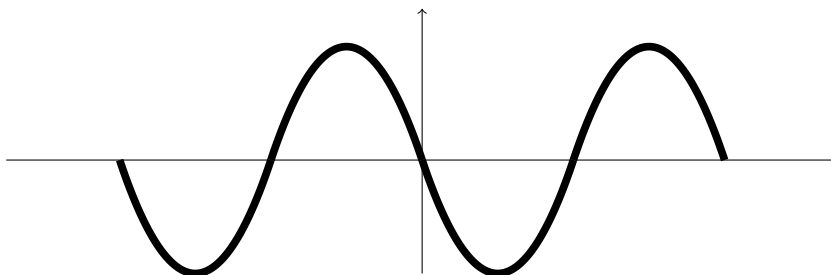

Discontinuous  
second derivative  $\Rightarrow$   
converges as  $1/n^3$

## Odd Functions

If  $m = 1, 2, 3, 4, 5, 6, 7 \dots$

and  $n = 2m - 1$  and  $m = \frac{n + 1}{2}$

then  $n = 1, 3, 5, 7, 9, 11, 13 \dots$

---

## Odd Functions

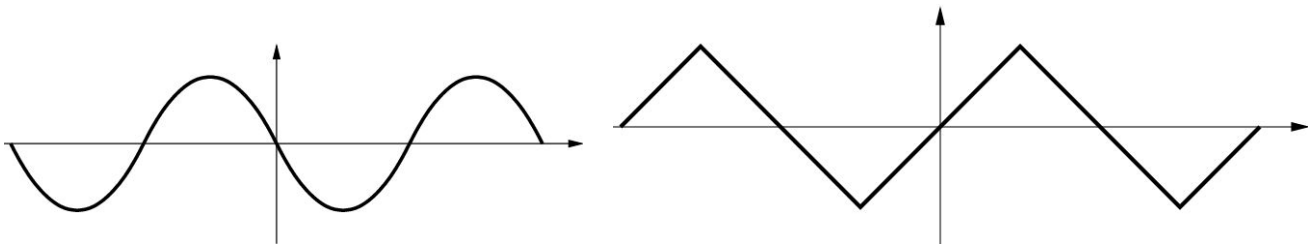

$$f(x) = -f(-x)$$

# 'Half-Range' Series

If we want to model a signal  $f(x) = x$  in the range 0 to  $T$ . We can use the Fourier formulae for general range to generate a variety of different series. They will all be the same in the range 0 to  $T$ , but some may converge faster than others.

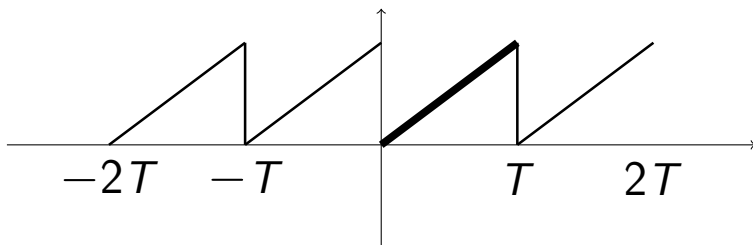

Full range series  
period  $T$   
converges as  $1/n$

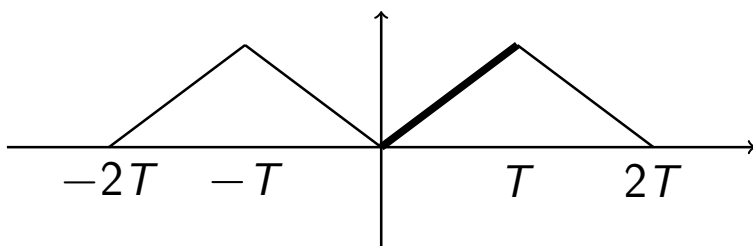

Cosine series  
period  $2T$ ,  $b_n = 0$   
converges as  $1/n^2$

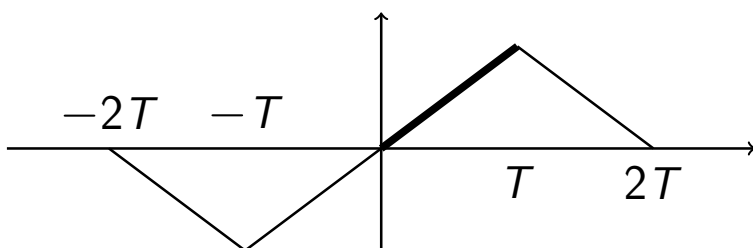

Sine series  
period  $4T$ ,  $a_n = 0$ ,  $a_0 = 0$   
converges as  $1/n$

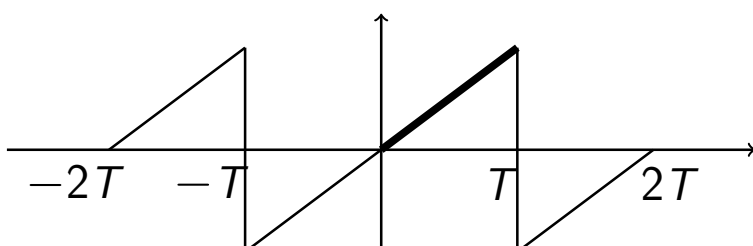

Sine series  
period  $2T$ ,  $a_n = 0$ ,  $a_0 = 0$   
converges as  $1/n$

# Normal Series, Period $T$

Find the Fourier series to model  $f(x) = x$  from 0 to  $T$ , using a series of period  $T$ .

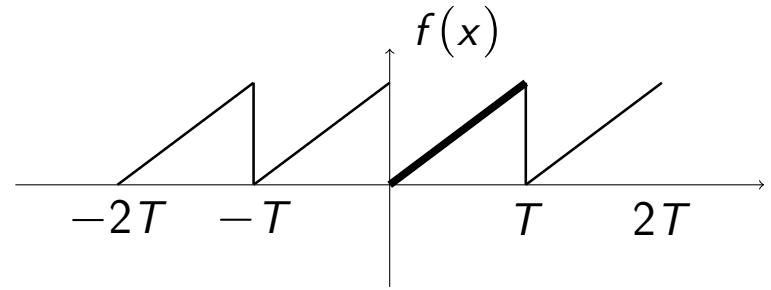

$$a_n = \frac{2}{T} \int_0^T \cos\left(\frac{2\pi nx}{T}\right) x \, dx = 0$$

$$b_n = \frac{2}{T} \int_0^T \sin\left(\frac{2\pi nx}{T}\right) x \, dx = \frac{-T}{n\pi}$$

$$a_0 = \frac{1}{T} \int_0^T x \, dx = \frac{T}{2}$$

$$\Rightarrow f(x) = \frac{T}{2} - \sum_{n=1}^{\infty} \frac{T}{n\pi} \sin\left(\frac{2\pi nx}{T}\right)$$



Notice that the series converges as  $1/n$ .

# Cosine Series, Period $2T$

Find the Fourier series to model  $f(x) = x$  from 0 to  $T$ , using a cosine series of period  $2T$ .

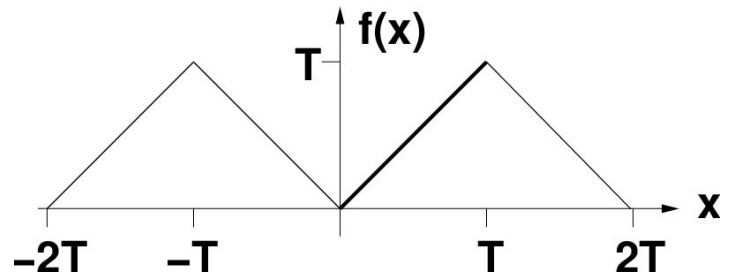

$$a_n = \frac{1}{T} \int_{-T}^T \cos\left(\frac{\pi nx}{T}\right) f(x) dx$$

$$= \frac{1}{T} \left[ \int_{-T}^0 \cos\left(\frac{\pi nx}{T}\right) (-x) dx + \int_0^T \cos\left(\frac{\pi nx}{T}\right) x dx \right]$$

$$= \frac{2}{T} \int_0^T \cos\left(\frac{\pi nx}{T}\right) x dx = \frac{-4T}{n^2 \pi^2}, \text{ only } n \text{ ODD}$$

$$a_0 = \frac{1}{2T} \int_{-T}^T f(x) dx = \frac{T}{2}$$

$$f(x) = \frac{T}{2} - \sum_{m=1}^{\infty} \frac{4T}{(2m-1)^2 \pi^2} \cos\left(\frac{(2m-1)\pi x}{T}\right)$$



Notice that the series converges as  $1/n^2$ .

# Sine Series, Period $4T$

Find the Fourier series to model  $f(x) = x$  from 0 to  $T$ , using a sine series of period  $4T$ .

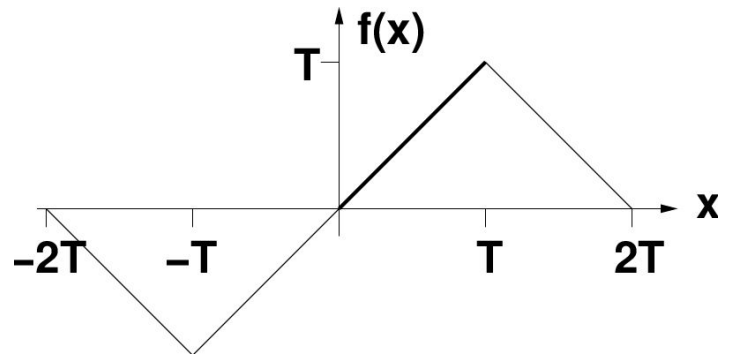

Notice how the function is symmetrical about  $T$  (i.e.  $\frac{1}{4}$  of the period). This leads to  $b_n = 0$  when  $n$  is even because all such terms are anti-symmetric about  $T$ . 

$$\begin{aligned}
 b_n &= \frac{1}{2T} \int_{-2T}^{2T} \sin\left(\frac{\pi nx}{2T}\right) f(x) dx \\
 &= \frac{1}{T} \int_{-T}^T \sin\left(\frac{\pi nx}{2T}\right) x dx, \quad n \text{ odd only} \\
 &= \frac{8T(-1)^{\left(\frac{n+3}{2}\right)}}{n^2\pi^2}, \quad n \text{ odd only}
 \end{aligned}$$

$$f(x) = \sum_{m=1}^{\infty} \frac{8T(-1)^{(m+1)}}{(2m-1)^2\pi^2} \sin\left(\frac{\pi(2m-1)x}{2T}\right)$$



Notice that the series converges as  $1/n^2$ .

# Sine Series, Period $4T$

Find the Fourier series to model  $f(x) = x$  from  $0$  to  $T$ , using a sine series of period  $2T$ .

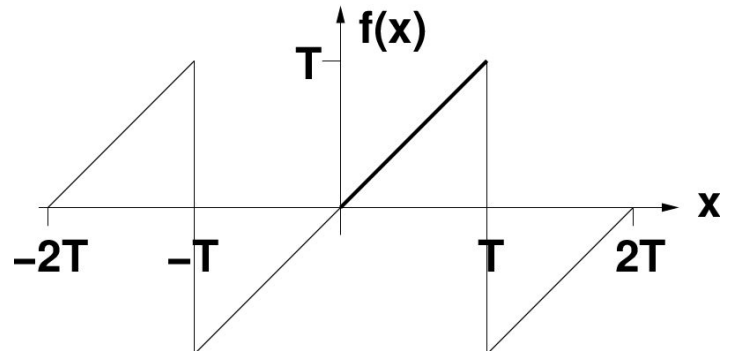

$$\begin{aligned} b_n &= \frac{1}{T} \int_{-T}^T \sin\left(\frac{\pi nx}{T}\right) x \, dx \\ &= \frac{-2T}{n\pi} (-1)^n \end{aligned}$$

$$\Rightarrow f(x) = \sum_{n=1}^{\infty} \frac{-2T}{n\pi} (-1)^n \sin\left(\frac{\pi nx}{T}\right)$$



Notice that the series converges as  $1/n$ .

# Section 7: Summary

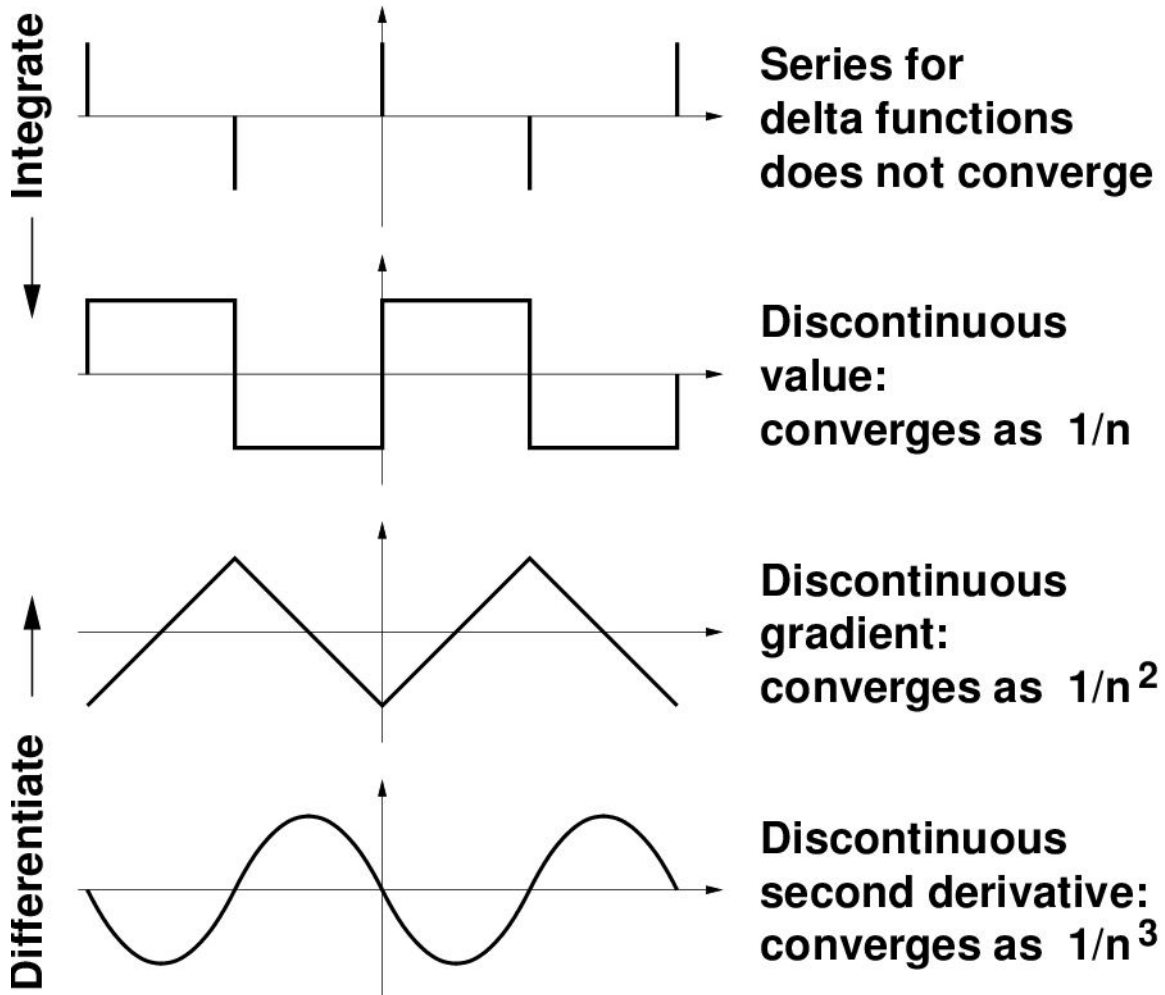

If you are modelling a limited section of a function, pick the Fourier series period so as to get good convergence and a series that is easy to calculate (i.e. some of  $a_n$ ,  $b_n$  or  $a_0$  zero).



# Section 8

## Complex Fourier Series

The complex Fourier series is presented first with period  $2\pi$ , then with general period.

The connection with the real-valued Fourier series is explained and formulae are given for converting between the two types of representation.

Examples are given of computing the complex Fourier series and converting between complex and real series.

# New Basis Functions

Recall that the Fourier series builds a representation composed of a weighted sum of the following basis functions.

$$\begin{array}{ccccccc}
 1 & \text{(i.e. a constant term)} & & & & & \\
 \cos(t) & \cos(2t) & \cos(3t) & \cos(4t) & \dots & & \\
 \sin(t) & \sin(2t) & \sin(3t) & \sin(4t) & \dots & & 
 \end{array}$$

Computing the weights  $a_n$ ,  $b_n$  and  $a_0$  often involves some nasty integration.

We now present an alternative representation based on a different set of basis functions:

$$\begin{array}{ccccccc}
 1 & \text{(i.e. a constant term)} & & & & & \\
 e^{it} & e^{2it} & e^{3it} & e^{4it} & \dots & & \\
 e^{-it} & e^{-2it} & e^{-3it} & e^{-4it} & \dots & & 
 \end{array}$$

These can all be represented by the term 

$$e^{int}$$

with  $n$  taking integer values from  $-\infty$  to  $+\infty$ . Note that the constant term is provided by the case when  $n = 0$ .

# Series of Complex Exponentials

A representation based on this family of functions is called the “complex Fourier series”.



$$f(t) = \sum_{n=-\infty}^{\infty} c_n e^{int}$$

The coefficients,  $c_n$ , are normally complex numbers.

It is often easier to calculate than the sin/cos Fourier series because integrals with exponentials in are usually easy to evaluate.

We will now derive the complex Fourier series equations, as shown above, from the sin/cos Fourier series using the expressions for  $\sin()$  and  $\cos()$  in terms of complex exponentials.

# Complex Fourier Series



$$\begin{aligned}
 f(t) &= a_0 + \sum_{n=1}^{\infty} [a_n \cos(nt) + b_n \sin(nt)] \\
 &= a_0 + \sum_{n=1}^{\infty} \left[ a_n \left( \frac{e^{int} + e^{-int}}{2} \right) + b_n \left( \frac{e^{int} - e^{-int}}{2i} \right) \right] \\
 &= a_0 + \sum_{n=1}^{\infty} \frac{(a_n - ib_n)}{2} e^{int} + \sum_{n=1}^{\infty} \frac{(a_n + ib_n)}{2} e^{-int} \\
 &= \sum_{n=-\infty}^{\infty} c_n e^{int}
 \end{aligned}$$

where

$$c_n = \begin{cases} a_0 & n = 0 \\ (a_n - ib_n) / 2 & n = 1, 2, 3, \dots \\ (a_{-n} + ib_{-n}) / 2 & n = -1, -2, -3, \dots \end{cases}$$

Note that  $a_{-n}$  and  $b_{-n}$  are only defined when  $n$  is negative.

$$\begin{aligned}a_n &= \frac{1}{\pi} \int_{-\pi}^{\pi} \cos(nt) f(t) dt \\b_n &= \frac{1}{\pi} \int_{-\pi}^{\pi} \sin(nt) f(t) dt \\a_0 &= \frac{1}{2\pi} \int_{-\pi}^{\pi} f(t) dt\end{aligned}$$

thus for  $n$  positive 

$$\begin{aligned}c_n &= \frac{1}{2} (a_n - ib_n) \\&= \frac{1}{2\pi} \int_{-\pi}^{\pi} [\cos(nt) - i \sin(nt)] f(t) dt \\&= \frac{1}{2\pi} \int_{-\pi}^{\pi} e^{-int} f(t) dt\end{aligned}$$

for  $n$  negative

$$\begin{aligned}c_n &= \frac{1}{2} (a_{-n} + ib_{-n}) \\&= \frac{1}{2\pi} \int_{-\pi}^{\pi} [\cos(-nt) + i \sin(-nt)] f(t) dt \\&= \frac{1}{2\pi} \int_{-\pi}^{\pi} e^{-int} f(t) dt\end{aligned}$$

and for  $n = 0$

$$\begin{aligned}c_0 &= a_0 \\&= \frac{1}{2\pi} \int_{-\pi}^{\pi} e^{-0} f(t) dt = \frac{1}{2\pi} \int_{-\pi}^{\pi} f(t) dt\end{aligned}$$

# Complex Fourier Series: Summary



$$c_n = \frac{1}{2\pi} \int_{-\pi}^{\pi} e^{-int} f(t) dt$$

$$f(t) = \sum_{n=-\infty}^{\infty} c_n e^{int}$$

# Complex Series: Example 1

Find the complex Fourier series to model  $f(t) = \sin(t)$ .



$$\begin{aligned} c_n &= \frac{1}{2\pi} \int_{-\pi}^{\pi} e^{-int} f(t) dt \\ &= \frac{1}{2\pi} \int_{-\pi}^{\pi} e^{-int} \sin(t) dt \\ &= \frac{1}{2\pi} \left[ \frac{e^{in\pi} - e^{-in\pi}}{n^2 - 1} \right] \quad \text{for } n \neq \pm 1 \end{aligned}$$

Which is zero since  $\sin n\pi = 0$  (for  $n \neq \pm 1$ ). For  $n = \pm 1$ , our integrals are

$$c_{\pm 1} = \frac{1}{2\pi} \int_{-\pi}^{\pi} e^{\pm it} \frac{(e^{it} - e^{-it})}{2i} dt$$

which can be straightforwardly evaluated to give:

$$c_1 = \frac{1}{2i} \quad c_{-1} = -\frac{1}{2i}$$

Which means the complex Fourier series for

$f(t) = \sin(t)$  is 

$$f(t) = \sum_{n=-\infty}^{\infty} c_n e^{int} = \frac{e^{it} - e^{-it}}{2i}$$

As expected!!

## Complex Series: Example 2

Find the complex Fourier series to model  $f(x)$  that has a period of  $2\pi$ , and is 1 when  $0 < x < T$  and zero when  $T < x < 2\pi$ .

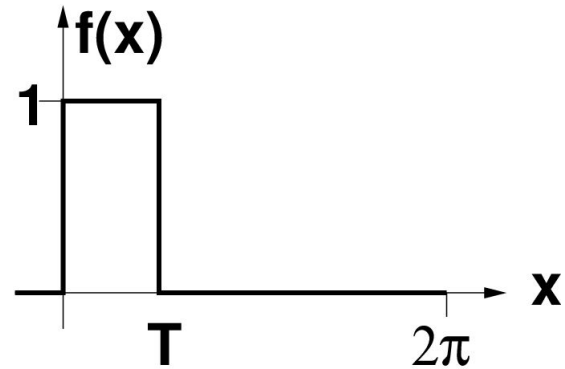

$$\begin{aligned}
 c_n &= \frac{1}{2\pi} \int_0^{2\pi} e^{-int} f(t) dt \\
 &= \frac{i}{2\pi n} \left[ e^{-inT} - 1 \right], \text{ when } n \neq 0 \\
 &= \frac{1}{2\pi} \times \text{area} = \frac{T}{2\pi}, \text{ when } n = 0
 \end{aligned}$$

So the Fourier series is 

$$\begin{aligned}
 f(t) &= \sum_{n=-\infty}^{\infty} c_n e^{int} \\
 &= \frac{1}{2\pi} \left\{ T + \sum_{n=-\infty, n \neq 0}^{+\infty} \frac{i}{n} \left[ e^{-inT} - 1 \right] e^{int} \right\}
 \end{aligned}$$



# Converting $c_n$ to $a_n$ and $b_n$

From our example on the previous page.

$$c_n = \begin{cases} \frac{i}{2\pi n} [e^{-inT} - 1] & \text{when } n \neq 0 \\ \frac{T}{2\pi} & \text{when } n = 0 \end{cases}$$

We can now calculate the coefficients for the equivalent Fourier series in terms of  $\sin()$  and  $\cos()$ .

Clearly  $a_0 = c_0 = \frac{T}{2\pi}$ . For  $n > 0$  

$$\begin{aligned} c_n &= (a_n - ib_n)/2 \\ \Rightarrow a_n &= 2 \mathbf{Re}\{c_n\} \\ \text{and } b_n &= -2 \mathbf{Im}\{c_n\} \end{aligned}$$

converting our expression for  $c_n$  into  $\sin()$  and  $\cos()$ :

$$\begin{aligned} 2c_n &= \frac{i}{\pi n} [\cos(nT) - i \sin(nT) - 1] \\ &= \frac{1}{\pi n} [\sin(nT) + i(\cos(nT) - 1)] \end{aligned}$$

$$\text{so } a_n = \frac{\sin(nT)}{n\pi} \quad \text{and} \quad b_n = \frac{1 - \cos(nT)}{n\pi}.$$

Therefore:

## Complex Fourier Series

$$f(t) = \frac{1}{2\pi} \left\{ T + \sum_{n=-\infty}^{-1} \frac{i}{n} \left[ e^{-inT} - 1 \right] e^{int} + \sum_{n=1}^{\infty} \frac{i}{n} \left[ e^{-inT} - 1 \right] e^{int} \right\}$$

## Real Fourier Series

$$f(t) = \frac{T}{2\pi} + \sum_{n=1}^{\infty} \frac{\sin(nT)}{n\pi} \cos(nt) + \sum_{n=1}^{\infty} \frac{1 - \cos(nT)}{n\pi} \sin(nt)$$



Both series converge as  $1/n$ . As they must!

# Converting from Real to Complex

Convert the real Fourier series of the square wave  $f(t)$  to a complex series.

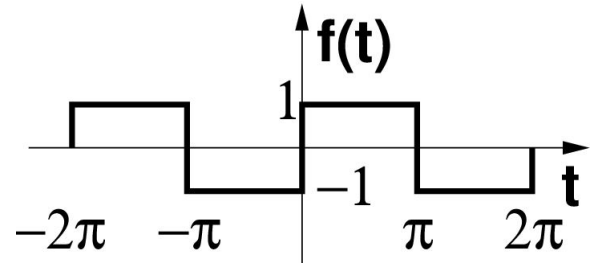

For the real series, we know that  $a_0 = a_n = 0$  and

$$b_n = \frac{1}{\pi} \int_{-\pi}^{\pi} \sin(nt) f(t) dt = \frac{4}{n\pi}, \quad n \text{ odd}$$

giving  $f(t) = \frac{4}{\pi} \left[ \sin(t) + \frac{\sin(3t)}{3} + \frac{\sin(5t)}{5} + \dots \right]$

To convert to a complex series, use

$$c_n = \begin{cases} a_0 & n = 0 \\ (a_n - ib_n) / 2 & n = 1, 2, 3, \dots \\ (a_{-n} + ib_{-n}) / 2 & n = -1, -2, -3, \dots \end{cases}$$

so we have 

$$c_0 = 0$$

$$c_n = -2i / (n\pi) \quad n \text{ positive and odd}$$

$$c_n = 2i / (-n\pi) \quad n \text{ negative and } |n| \text{ odd}$$

$$\Rightarrow f(t) = \frac{-2i}{\pi} \left[ \dots + \frac{e^{-5it}}{-5} + \frac{e^{-3it}}{-3} + \frac{e^{-it}}{-1} + \frac{e^{it}}{1} + \frac{e^{3it}}{3} + \frac{e^{5it}}{5} + \dots \right]$$

# General Complex Series

For period of  $2\pi$

$$c_n = \frac{1}{2\pi} \int_0^{2\pi} e^{-int} f(t) dt \equiv \frac{1}{2\pi} \int_{\alpha}^{\alpha+2\pi} e^{-int} f(t) dt$$

$$f(t) = \sum_{n=-\infty}^{\infty} c_n e^{int}$$

Similarly, for period  $T$

$$c_n = \frac{1}{T} \int_0^T e^{-int \frac{2\pi}{T}} f(t) dt$$

$$f(t) = \sum_{n=-\infty}^{\infty} c_n e^{int \frac{2\pi}{T}}$$



The fraction  $\frac{2\pi}{T}$  is often written as  $\omega_0$  and called the *fundamental angular frequency* (as seen previously).

# Example 1

An even function  $f(t)$  is periodic with period  $T = 2$ , and  $f(t) = \cosh(t - 1)$  for  $0 \leq t \leq 1$ . Find a complex Fourier series representation for  $f(t)$ . It seems sensible to use the cosh function that we have used previously:

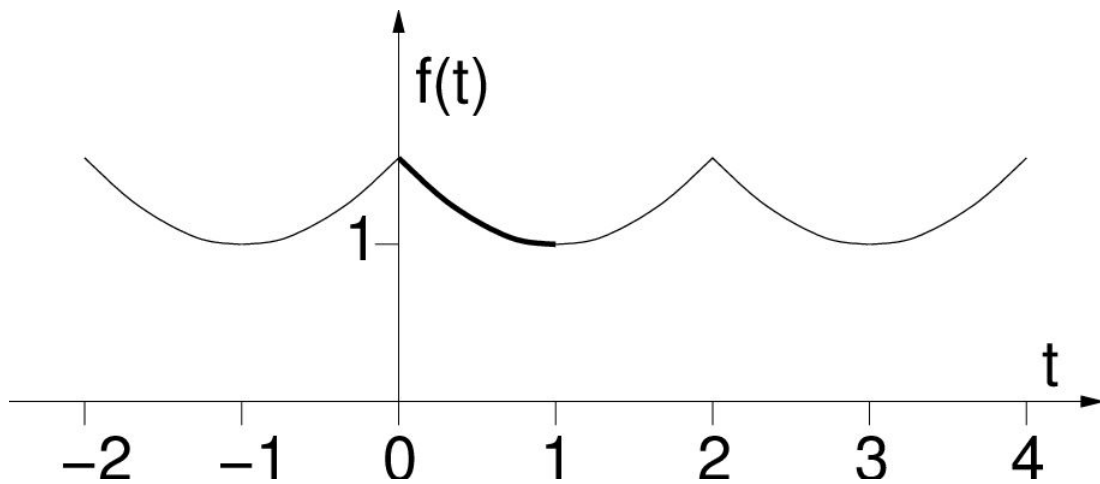

$$\begin{aligned}
 c_n &= \frac{1}{T} \int_0^T e^{-int\frac{2\pi}{T}} f(t) dt \\
 &= \frac{1}{2} \int_0^2 e^{-int\pi} \cosh(t-1) dt \\
 &= \frac{\sinh(1)}{1+n^2\pi^2}
 \end{aligned}$$

Hence the complex Fourier series is

$$\begin{aligned} f(t) &= \sum_{n=-\infty}^{\infty} c_n e^{int\frac{2\pi}{T}} \\ &= \sum_{n=-\infty}^{\infty} \frac{\sinh(1)e^{int\pi}}{1+n^2\pi^2} \end{aligned}$$

We can check this answer by computing the equivalent real Fourier series which we calculated at the start of section 7.

$$\begin{aligned} a_n &= 2 \mathbf{Re}\{c_n\} & n = 1, 2, 3, \dots \\ b_n &= -2 \mathbf{Im}\{c_n\} & n = 1, 2, 3, \dots \\ a_0 &= c_0 \end{aligned}$$

In this case, as  $c_n$  is entirely real, 

$$a_n = 2c_n = \frac{2 \sinh(1)}{1+n^2\pi^2}, \quad n = 1, 2, 3, \dots$$

$$b_n = 0$$

$$a_0 = \sinh(1)$$

## Example 2

Find the complex Fourier series of the square wave  $f(x)$ .

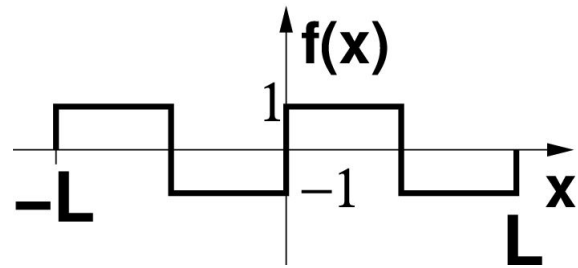

➤ Note that the mean of the function is zero, so  $c_0 = 0$ .

$$\begin{aligned} c_n &= \frac{1}{L} \int_0^L e^{-inx \frac{2\pi}{L}} f(x) dx \\ &= \frac{1}{L} \left[ \int_0^{L/2} e^{-inx \frac{2\pi}{L}} dx - \int_{L/2}^L e^{-inx \frac{2\pi}{L}} dx \right] \\ &= \frac{1}{2in\pi} \left[ e^{-2in\pi} + 1 - 2e^{-in\pi} \right] \end{aligned}$$

$$f(x) = \sum_{\substack{n = -\infty \\ n \neq 0}}^{\infty} \frac{[1 - e^{-in\pi}]}{in\pi} e^{inx \frac{2\pi}{L}}$$

$$f(x) = \frac{2}{i\pi} \left[ \dots + \frac{e^{-5ix \frac{2\pi}{L}}}{-5} + \frac{e^{-3ix \frac{2\pi}{L}}}{-3} + \frac{e^{-ix \frac{2\pi}{L}}}{-1} \right. \\ \left. + \frac{e^{ix \frac{2\pi}{L}}}{1} + \frac{e^{3ix \frac{2\pi}{L}}}{3} + \frac{e^{5ix \frac{2\pi}{L}}}{5} + \dots \right]$$

# Converting to a Real Series

We wish to convert the complex general range square wave series into a series with real coefficients.

$$c_n = \begin{cases} 2/(in\pi) & |n| \text{ odd} \\ 0 & |n| \text{ even} \end{cases}$$

Clearly  $a_0 = c_0 = 0$ . For  $a$  and  $b$  use: 

$$\begin{aligned} c_n &= (a_n - ib_n)/2 \\ \Rightarrow a_n &= 2 \mathbf{Re}\{c_n\} = 0 \\ \text{and } b_n &= -2 \mathbf{Im}\{c_n\} = \frac{4}{n\pi}, \quad n \text{ odd} \end{aligned}$$

Which gives us the real series:

$$f(t) = \frac{4}{\pi} \left[ \sin \left( x \frac{2\pi}{L} \right) + \frac{\sin \left( 3x \frac{2\pi}{L} \right)}{3} + \frac{\sin \left( 5x \frac{2\pi}{L} \right)}{5} + \dots \right]$$



# Section 8: Summary

For period  $L$



$$c_n = \frac{1}{L} \int_0^L e^{-inx \frac{2\pi}{L}} f(x) dx \equiv \frac{1}{L} \int_0^L e^{-inx\omega_0} f(x) dx$$

$$f(x) = \sum_{n=-\infty}^{\infty} c_n e^{inx \frac{2\pi}{L}} \equiv \sum_{n=-\infty}^{\infty} c_n e^{inx\omega_0}$$

Relationship with the cos/sin Fourier series.

$$c_n = \begin{cases} a_0 & n = 0 \\ (a_n - ib_n) / 2 & n = 1, 2, 3, \dots \\ (a_{-n} + ib_{-n}) / 2 & n = -1, -2, -3, \dots \end{cases}$$

$$a_n = 2 \operatorname{Re}\{c_n\} \quad , \quad n = 1, 2, 3, \dots$$

$$b_n = -2 \operatorname{Im}\{c_n\} \quad , \quad n = 1, 2, 3, \dots$$

$$a_0 = c_0$$